

The Influence of Lubricant Viscosity in Cold Work Forward Extrusion Using Micro-Pits Tool

A. Norhayati^{a*}, S. Maizan^a, H.M. Zin^b, J.Y. Wira^c, W.B. Wan Nik^d, S. Syahrullail^e

^aDepartment of Mechanical Engineering, Politeknik Ibrahim Sultan, Km10, Jalan Kong Kong, 81700 Pasir Gudang, Johor, Malaysia.

^bDepartment of Electrical Engineering, Politeknik Sultan Salahuddin Abdul Aziz Shah, Seksyen U1, 40150 Shah Alam, Selangor, Malaysia. (mohdzin@psa.edu.my)

^cMalaysia-Japan International Institute of Technology, UTM International Campus, Jalan Semarak, 54100 Kuala Lumpur, Malaysia. (wira@ic.utm.my)

^dUniversiti Malaysia Terengganu, 21030 Kuala Terengganu, Malaysia. (niksani@umt.edu.my)

^eFaculty of Mechanical Engineering, Universiti Teknologi Malaysia, 81310 UTM Skudai, Johor, Malaysia. (syahruls@fkm.utm.my)

*Corresponding author: hayati_a@polijb.edu.my

Article history

Received :15 June 2012

Received in revised form :12 August 2012

Accepted :28 August 2012

Graphical abstract

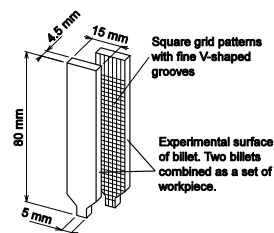

Abstract

The present research concerns on the study of the effects of micro-pits arrays formed on taper die using cold forward plane strain extrusion experiments. Each pit was of reverse pyramids configuration having 330 microns diagonal length. The pits were 860 microns apart each others. Two additive free paraffinic mineral oils with low viscosity (P2) and high viscosity (P3) were used in this experimental work. The experimental results were compared with the results obtained from the plane strain extrusion experimental works with taper die without micro-pits (NA). The experimental results focused on the extrusion load, billet surface roughness and billet grid pattern on inclination slope. From the results, the existence of the micro-pits array on the taper die surface affected the extrusion load. At the same time, the micro-pits array affected the extruded billet surface roughness after the experiments. From this experiment, we could conclude that the micro-pits formed on the taper die (PA) would control the frictional constraint on the taper die compared to those without the micro-pits (NA). However, high viscosity lubricant (P3) was found to cause more effects compared to low viscosity lubricant (P2).

Keywords: Oil pocket, micro-pit, extrusion, surface roughness, paraffinic mineral oil

© 2012 Penerbit UTM Press. All rights reserved.

1.0 INTRODUCTION

Extrusion is a bulk forming process commonly used to produce long and straight metal parts, which the shape of the cross section can be solid round, rectangular, T shapes, H shapes, tubes and et cetera. The quality of extruded product depends on many technological factors and proper die design. One of the most successful applications in engineering is the improvement of tribological performance. Observations on the surface topography of some engineering surfaces have suggested that systematic patterning could lead to optimized behaviour, as a logical development of the more random texturing achieved through processes such as abrasive finishing and honing. Different mechanisms may contribute towards better tribological performance.

It is well known that surface texture plays an important role in the cold extrusion of metals. Although there have been wide studies on this problem, but there is a little information about the effect of micro-pits (also known as dimples, holes, oil pockets or cavities) existence improvement of tribological properties in controlling a cold forward extrusion process investigated by

Geiger *et al.* (1997). Previous researchers like Osakada, (1977) and Azushima *et al.* (1996) found that the lubricant was entrapped in the interface between the tool and work piece and the hydrostatic pressure was generated within the lubricant entrapped within the pocket. There are similar researches was done on the effect of surface topography on car braking system to contribute towards better tribological performance (Ahmad Razimi *et al.* 2012).

In strip drawing process, Costa and Hutchings (2009) found that plastic deformation of a metal strip took place as it was pulled through a converging channel formed by stationary dies. Deformation in the strip occurred under the combination of the longitudinal stress and compressive stresses generated in the die. The bar had a rectangular cross-section and the deformation condition approximated to plane strain. The deforming strip slid over the whole contact zone.

Kamitani *et al.* (2005) found that micro-pits array on the tool surface affected the extrusion load, effective strain and the material flow condition near the contact surface of the tool but billet surface roughness showed no obvious changes. From the result, their found that compared to plane tool, using the tool

having pits array showed that extrusion loads, shear strain and effective strain became higher. However, if the viscosity of lubricant was high, the value of frictional constraint became lower compared to plane plate tool. They also found that, influence of the pits array on the shear strain and effective strain was not obvious when using the lower viscosity of lubricant. In present study, the effects of micro-pits array on the taper die in cold work plain strain extrusion process were investigated. The results focused on the extrusion load and surface roughness of the billet.

2.0 EXPERIMENTAL WORKS

2.1 Experimental Apparatus

The experimental set-up of the plane strain extrusion apparatus is depicted in Figure 1. The main components were container wall, taper die, and work-piece (billet). This experiment was conducted using hydraulic press machine at room temperature. A specific amount of test lubricant was applied in the taper die surface that was in contact with the billet (shown in dotted line in Figure 1). The details of the experimental apparatus could be found in previous publication (Syahrullail *et al.* 2005). The billets were cleaned using acetone before the experiment. During the extrusion process, two similar billets were stacked and used as one unit, fixed on a container and extruded using a pair of taper dies. The plane strain extrusion apparatus was assembled and placed on the load cell to record the extrusion load during each test. The displacement of ram stroke was recorded by using the displacement sensor. The extrusion was stopped at a piston stroke of 30 mm, where the extrusion process was in steady state condition. The ram speed was constant at 7.6 mm/s.

For micro-pit experiment, a set of micro-pits array was constructed on the taper surface (in contact with the billet). As a comparison, similar experimental works were conducted with taper die without micro-pits array. After the experiment, the partially extruded billets were taken out from the plane extrusion apparatus. The surface roughness of the billet with the observation plane was measured and the extrusion load was analyzed.

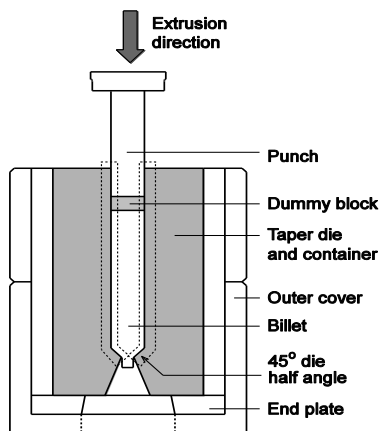

Figure 1 A schematic sketch of plane strain extrusion apparatus. The dotted line shows the experimental surface of taper die which test lubricant was applied before the experiments

2.2 Billet

The billet material was pure aluminium A1100. The pure aluminium specimen was 4.5 mm in thickness with 15 mm in

width and 80 mm in length. Figure 2 depicts the schematic sketch of billets used in the experiments. Two similar billets were stacked and used as one unit of billet. One side of the contact surface of the combined billets was the observation plane of plastic flow in plain strain extrusion. The observation plane was not affected by the frictional constraint from the parallel side walls. A square grid pattern measuring the material flow in extrusion process was scribed by NC milling machine on the observation plane of billet. The grid lines were V-shaped grooves with 1.0 mm × 1.0 mm with 0.3 mm deep. The billets were annealed before the experiments. The experimental surface of billet (surface in contact with the taper die) had surface roughness Ra approximately 2.5 micron and the hardness of the billet was 31 Hv.

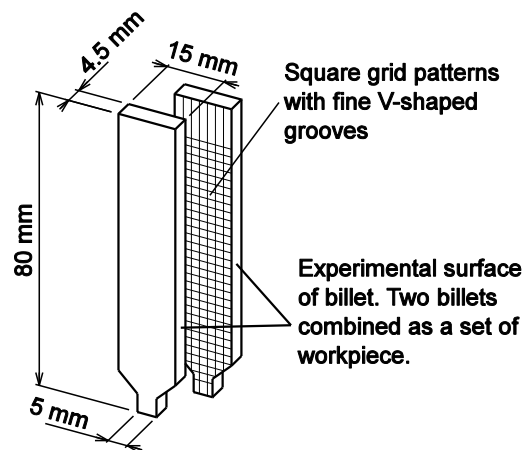

Figure 2 Schematic sketch of billet and its combination.

2.3 Taper Die

The taper dies used in the experiments were made from JIS-SKD11 tool steel. All these taper dies had a uniform dimension. A taper die without micro-pits was designated as taper die NA and used as a reference. Taper dies with micro-pits array were prepared and designated as taper die PA. All taper dies used in the experimental works are shown in Figure 3(a), and Figure 3(b) shows the photograph of the micro-pits array on the taper die surface. Each pit was reverse pyramids configuration having 330 microns diagonal length. The pits were 860 microns apart each others, and 61 microns of depth.

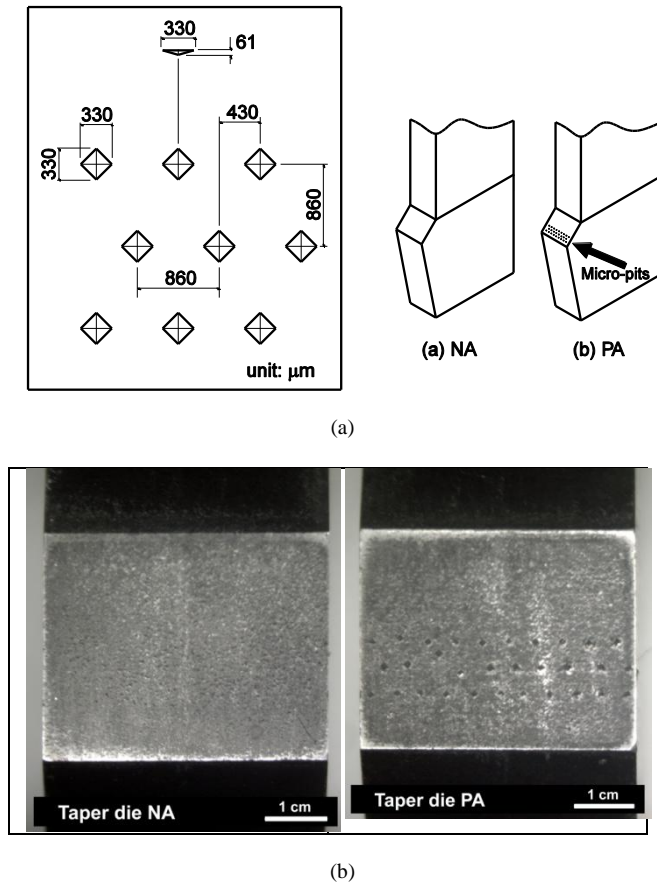

Figure 3(a) A schematic sketches of the micro-pits arrangement and location; (b) A photograph of the micro-pits array on the taper die surface

2.4 Lubricants

The experiments were conducted under lubricated conditions. The testing lubricant was additive-free paraffinic mineral oil with two different viscosities, of low and high viscosity paraffinic mineral oils and marked as P2 and P3 respectively. P2 had kinematic viscosity of 90.12 cSt while P3 had 460 cSt at 40°C. The details of the testing lubricants are depicted in Table 1. One drop of lubricant (approximately 18mg) was applied on each surface of the experimental taper die before the experiment. The initial lubricant amount was predicted to create full film (hydrodynamics) lubrication regime at the early stage of extrusion process.

Table 1 Properties of paraffinic oil P2 and P3

Parameters	P2	P3	Test Method
Density @ 15°C (kg/liter)	0.8725	0.9035	ASTM D1298-85(90)
API Gravity	26.66	25.03	ASTM D1298-85(90)
Kinematic Viscosity @ 40°C, cSt	90.12	460.00	ASTM D445-94

3.0 RESULTS AND DISCUSSION

Figure 4(a) depicts the extrusion load - piston stroke curves when lubricant P2 (low viscosity) was applied. At the early stage of extrusion process (at piston stroke 0mm to 10mm), the forming load for extrusion taper die without micro-pits (NA) was slightly lower compared with taper die with micro-pits (PA). At the end (steady state condition) of the extrusion process (piston stroke 30mm), the extrusion using taper die with micro-pits (PA) showed almost the same extrusion load compared to those extruded with taper die without micro-pits. The lubricant was trapped in the micro-pits. However, low viscosity lubricant (P2) easily flowed out during the extrusion making the micro-pits array unable to hold and maintain the lubricant film layer consistently.

Figure 4(b) depicts the extrusion load - piston stroke curves when lubricant P3 (high viscosity) was applied. At the early stage of extrusion (at piston stroke 0mm to 10mm), the existence of micro-pits array on the taper die surface could hold the lubricant and maintain the formation of the lubricant layer. Thus, this reduce the metal-to-metal contact between the billet and taper die. As a result, the extrusion loads for those extruded using taper die without micro-pits (NA) were higher compared to those extruded using taper die with micro-pits (PA). However, at the end of the extrusion process, the extrusion load for taper die PA increased and became higher compared to using taper die NA due to the high viscosity of lubricant P3. This lubricant had high viscosity. When using taper die with micro-pits array, the lubricant was entrapped in the micro-pits and had less possibility to flow out during the extrusion process. The lubricant film maintained and increased the shear stress between the billet and taper die. Therefore, the extrusion load of billet extruded using taper die with micro-pits was higher compared to those extruded using taper die without micro-pits.

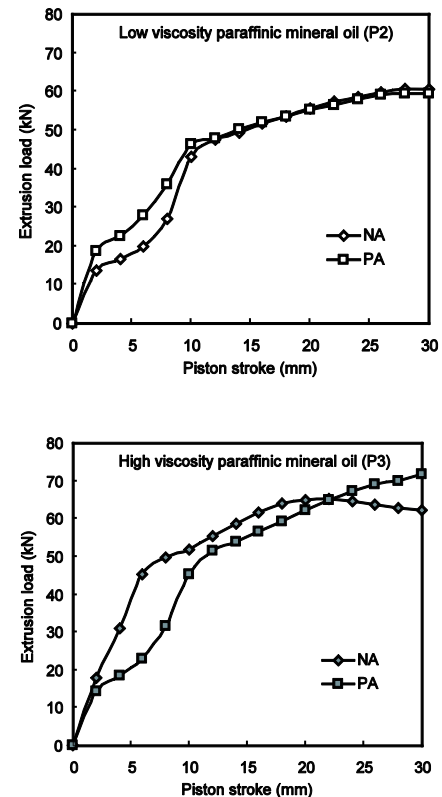

Figure 4 Extrusion load-piston stroke curves for (a) lubricant P2 and (b) lubricant P3

3.1 Surface Roughness

After the experiment, the billets were taken out from the experimental apparatus. Each billet was cleaned using acetone to make sure that there was no lubricant film and debris left of the surface. The remaining lubricant could cause an error while measuring the surface roughness. After that, the surface roughness, Ra, along the experimental surface of the billet was measured and plotted as shown in Figure 5. The measurement was made using a surface profilometer, and perpendicular to the extrusion direction. In Figure 5, the plane along the experimental surface of billet is taken as an X-axis.

Area of $X=14\text{mm}$ to $X=8\text{mm}$ was the undeform area of billet. Area of $X=6\text{mm}$ to $X=0\text{mm}$ was the area of deformation of billet. In this area, billet entered the taper die and started to change its direction and cross sectional area. Area of $X=0\text{mm}$ to $X=-8\text{mm}$ was the product area where the billet passed through the taper die. Here, there was no more deformation, since the billet was not in contact with the taper die.

For the extrusion work lubricated with low viscosity P2, there were no significant changes that could be concluded. All conditions of taper die gave almost similar patterns of surface roughness of the billet. At the product side ($X=-2\text{mm}$), the surface roughness was around 0.9 to 1.0 micron. The extrusion load also showed no significant changes between the taper die with and without micro-pits array.

For the extrusion work lubricated with high viscosity P3, the existence of micro-pits on the taper die surface could hold the lubricant from thinning off during the extrusion process. This maintained the lubricant supply and prevented metal-to-metal contact (Lu et al., 1985). As a result, the surface roughness at taper die ($X=0\text{mm}$ to $X=6\text{mm}$) was lower for those extruded with taper die with micro-pits compared to taper die without micro-pits array. The surface roughness value at product area ($X=-2\text{mm}$) was around 0.9 micron.

For the taper die without micro-pit (NA), the lubricant would flow away and increase the metal-to-metal contact that caused asperities, and made the billet surface become coarser. At product side ($X=-2\text{mm}$), the billet extruded with taper die without micro-pits was around 1.12 micron.

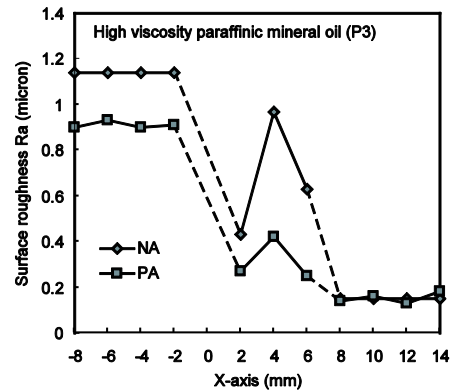
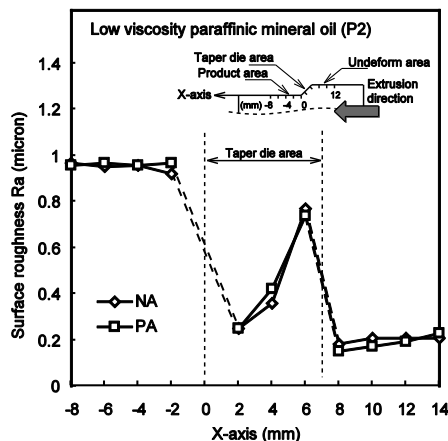

Figure 5 Surface roughness distributions when (a) lubricant P2 and (b) lubricant P3 was applied

Figure 6 depicts the coordinates used to measure the inclination of grid lines near the taper die. The taper die surface was chosen because the deformation zone of billet lay in this area. Based on the inclination degree of grid lines, the friction condition between the taper die and billet surface could be justified. The frictional constraint increased as the inclination degree decreased.

Figure 7 depicts the grid slope inclination distribution of the billet slide on the taper die. The deformation of billet started at 7mm. This point is called an inlet of the deformation area. The deformation ended at 0mm, and called an exit of the deformation area.

The inclination degree was greater at the inlet of the deformation area and decreased towards the exit of the deformation area due to the increment of the extrusion ratio.

All experimental conditions showed that the billet had greater inclination degree (slope) at the inlet of the deformation area ($X=7\text{mm}$), and decreased at the exit of the deformation area of billet ($X=1\text{mm}$). The low viscosity lubricant (P2) had higher frictional constraint compared to high viscosity lubricant (P3). It was because the low viscosity lubricant easily flowed and thinned off during the extrusion process compared to the high viscosity lubricant.

For the extrusion work lubricated with high viscosity P3, the billet extruded with taper die with micro-pits (PA) showed a slightly greater slope inclination degree compared to those extruded with taper die without micro-pits (NA). This shows that the frictional constraint for taper die PA was slightly lower compared to taper die NA. However, the increment of the extrusion load was not caused by the metal-to-metal contact, but it was caused by the increment of lubricant film thickness (due to its shear stress).

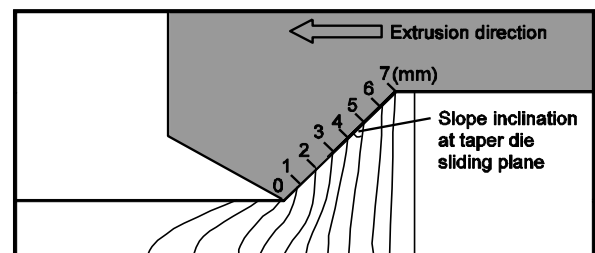

Figure 6 Coordinates used to measure the grid inclination at taper die

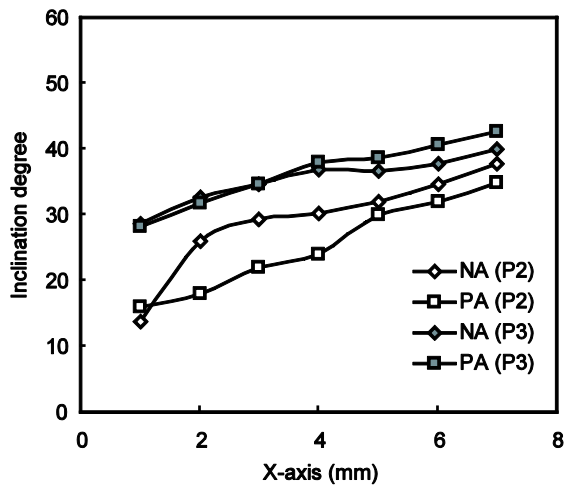

Figure 7 Grid inclination distributions when lubricant P2 and P3 applied

3.1 Surface Observation

After the experiments, the tool and billet experimental surface were cleaned with acetone and observed using CCD camera. From the observation, the extruded surface of billet showed some galling marks due to the contact with the taper die. However, there were no obvious difference between the billet extruded with (PA) and without micro-pits array (NA). There were no severe wear found.

Figure 8 shows the CCD picture of taper die experimental surface with micro-pits array (PA) using low (P2) and high (P3) viscosity paraffinic mineral oil. There were no severe wear found for both conditions. The usage of different viscosity of test lubricants also did not affect the structure of the micro-pits. However, for experimental works which were done using low viscosity lubricant (P2), there was a possibility for the billet material to trap in the micro-pit (white debris) but it was not dominant (Kamitani *et al.* 2008). For high viscosity lubricant (P3), there were no example of this phenomenon.

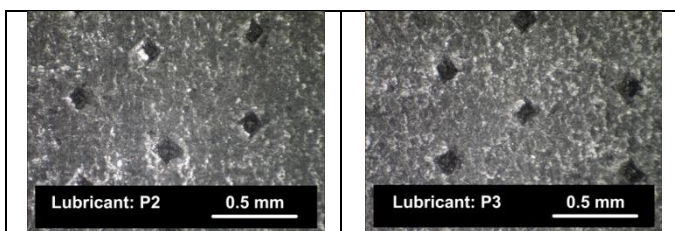

Figure 8 CCD picture of micro-pits array after the experiments

4.0 CONCLUSION

Experimental works of billet extruded with (PA) and without micro-pits taper die (NA) were conducted using cold work plane strain extrusion apparatus. For the extrusion work using low

viscosity paraffinic mineral oil (P2), the existence of micro-pits array on the taper die showed no difference compared to the taper die without micro-pits array (PA). However, for the high viscosity paraffinic mineral oil (P3), the extrusion using taper die with micro-pits array (PA) showed an increment of the extrusion load at steady state extrusion condition and low value of surface roughness, Ra. It was caused by the lubricant that was trapped in the micro-pits and formed a lubricant layer. At the same time, this could supply the lubricant along the process. The frictional constraint could be reduced, as the inclination slope of billet extruded using taper die with micro-pits array had a greater inclination degree compared to those extruded using taper die without micro-pits array.

Acknowledgement

The authors wish to thank the Department of Mechanical Engineering at the Politeknik Ibrahim Sultan and Faculty of Mechanical Engineering at the Universiti Teknologi Malaysia for their support and cooperation during this study. The authors also wish to thank the Research University Grant (GUP) from the Universiti Teknologi Malaysia, the Ministry of Higher Education (MOHE) and the Ministry of Science, Technology and Innovation (MOSTI) of Malaysia for their cooperation and financial support.

References

- [1] Ahmad Razimi, M. L., Abdul Hamid, M. K. and Abd Rahim, A. B. 2012. Effects of Pad Surface Topography on Disc Brake Squeal. *Applied Mechanics and Materials*. 165: 58–62.
- [2] Azushima, A., Yoneyama, S., Yamaguchi, T. and Kudo, H. 1996. Direct Observation of Microcontact Behavior at the Interface between Tool and Workpiece in Lubricated Upsetting. *CIRP Annals-Manufacturing Technology*. 45(1): 205–210.
- [3] Costa, H. L. and Hutchings, I. M. 2009. Effects of Die Surface Patterning on Lubrication in Strip Drawing. *Journal of Materials Processing Technology*. 209(3): 1175–1180.
- [4] Geiger, M., Engel, U. and Pfestorf, M. 1997. New Developments for the Qualification of Technical Surfaces in Forming Processes. *CIRP Annals - Manufacturing Technology*. 46(1): 171–174.
- [5] Kamitani, S., Nakanishi, K. and Syahrullail, S. 2005. The Effect of Micro-pits Formed on the Tool Surface on Metal Flow under Bulk Plastic Deformation. *International Tribology Conference*. Kobe, Japan. 254.
- [6] Kamitani, S., Nakanishi, K. and Syahrullail, S. 2008. Improvement of Surface Roughness of Aluminum Products by the Micro-Grooves on Tool Surface in Cold Extrusion. *Journal of Japan Institute of Light Metal*. 58(3): 111–116.
- [7] Lu, S. S. and Chuang, Y. H. 1985. Effects of Surface Roughness on Lubrication in Cold Rolling of Metals. *Journal of Tribology*. 107(4): 522–526.
- [8] Osakada, K. A. 1977. Mechanism of Lubricant Trapping in Slow Speed Compression. *International Journal of Mechanical Sciences*. 19(7): 413–421.
- [9] Syahrullail, S., Nakanishi, K. and Kamitani, S. 2005. Investigation of the Effects of Frictional Constraint with Application of Palm Olein Oil Lubricant and Paraffin Mineral Oil Lubricant on Plastic Deformation by Plane Strain Extrusion. *Journal of Japanese Society of Tribologist*. 50(12): 877–885.