

## Behaviour of Reinforced Concrete Infilled Frames Under Seismic Loads

A. Kadid<sup>a\*</sup>, S. Noui<sup>a\*</sup>, A. Zine<sup>a</sup>, D. Yahiaoui<sup>b</sup>

<sup>a</sup>Department of Hydraulics, University of Batna, UHLB-LRHYA, CNERIB, CTC-SUD-Batna, Algeria

<sup>b</sup>Department of Civil Engineering, University of Constantine-Constantine, Algeria

\*Corresponding author: abdelkrim.kadid@gmail.com

### Article history

Received :1 November 2012  
Received in revised form :15 January 2013  
Accepted :15 March 2013

### Graphical abstract

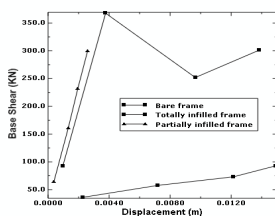

### Abstract

A significant portion of the buildings constructed in Algeria is structural frames with infill panels which are usually considered as non structural components and are neglected in the analysis. However, these masonry panels tend to influence the structural response. Thus, these structures can be regarded as seismic risk buildings, although in the Algerian seismic code there is little guidance on the seismic evaluation of infilled frame buildings. In this study, three RC frames with 2, 4 and 8 storey and subjected to three recorded Algerian accelerograms are studied. The diagonal strut approach is adopted for modeling the infill panels and a fiber model is used to model RC members. This paper reports on the seismic evaluation of RC frames with brick infill panels. The results obtained show that the masonry panels enhance the load lateral capacity of the buildings and the infill panel configuration influences the response of the structures.

**Keywords:** Infill panels; non linear dynamic analysis; RC frames; seismic design

### Abstrak

Sebahagian besar daripada bangunan yang dibina di Algeria adalah bingkai struktur dengan panel terisi yang biasanya dianggap sebagai komponen bukan struktur dan tidak diambil kira dalam analisis. Walau bagaimanapun, panel batuan ini cenderung untuk mempengaruhi tindak balas struktur. Oleh itu, struktur ini boleh dianggap sebagai bangunan yang berisiko akibat dari kesan gempa, walaupun dalam kod gempa di Algeria terdapat sedikit panduan kepada penilaian gempa untuk bangunan dengan rangka terisi. Dalam kajian ini, tiga kerangka konkrit bertetulang dengan 2, 4 dan 8 tingkat dan tertakluk kepada tiga rekod accelerogram di Algeria telah dikaji. Pendekatan tupang pepenjuru diguna pakai untuk model panel terisi dan model gentian digunakan untuk pemodelan kerangka konkrit bertetulang. Kertas kerja ini melaporkan penilaian gempa kerangka konkrit bertetulang dengan panel terisi bata. Keputusan yang diperolehi menunjukkan bahawa panel batu telah meningkatkan keupayaan sisi beban bangunan dan susun atur panel terisi telah mempengaruhi tindak balas struktur.

**Kata kunci:** Panel terisi; analisis dinamik bukan linear; kerangka konkrit bertetulang; reka bentuk gempa

© 2013 Penerbit UTM Press. All rights reserved.

### 1.0 INTRODUCTION

Structural systems consisting of RC frames with inter columns totally or partially infilled with masonry panels are common in many countries situated in high seismicity areas. Infill panels, though considered as non structural elements, can drastically modify the frame behavior under seismic loads by increasing the lateral stiffness and strength. The interaction between the infill and the frame has a dual effect: it may or may not improve the seismic performance of the composite structure. During an earthquake, the loss of infill walls has serious implications not only for the safety but also for the functionality of the building. The brittle disintegration of infill panels can seriously compromise the life safety. Infill walls have been identified as a contributing factor to structural failure in earthquakes

Frame/partial wall interactions can cause brittle shear failures of reinforced concrete columns and short column effect. In addition, infills can over strengthen the upper stories of a structure and result in a soft story, which is potentially dangerous from the safety point of view. Despite the fact that shortcomings of this type of structure have been observed, there is a strong laboratory and field evidence that masonry infills may improve the seismic performance of a structure if they are properly designed. The behavior of infilled frames under seismic loads has been investigated by a number of researchers. Most studies on infill wall behavior aimed to understand their contribution in terms of strength in the assessment of the resistant capacity of existing buildings. Extensive experimental studies [Asteris.(2003), Buonopane, and White (1999).Dhanasekar. and Page (1986). Liauw, and Kwan (1984).

Mehrabi *et al.* (1996), and Moghaddam (2004)] and semi-analytical investigations [Page *et al.* (1985), Saneinejad, and Hoobs (1995), Santhi *et al.* (2005), and Smith (1996)] have been made.

## 2.0 MODELING STRATEGIES

Modelling masonry infill panels requires a detailed description of materials. Masonry is a brittle material that exhibits distinct directional properties due to the mortar joints which act as plane of weakness. Attempts at the analysis of unfilled frames since Mid-1950 have yielded several analytical models. These analytical models can be classified as macro and micro models depending on their complexity, the detail by which they model an infill wall, and the information they provide concerning the behaviour of the structure. A basic characteristic of a macro-model is that it tries to encompass the overall global behaviour of a structural element without modelling all the possible modes of local failure. On the other hand, micro-models model the structural element behaviour with great detail trying to consider possible modes of failure. In the macro model, the effect of the masonry infilling wall is considered as equivalent to a diagonal strut, figure 1.a. This approach is simple and computationally attractive but is theoretically weak, because it is not straightforward to identify the equivalent nonlinear stiffness of the infill masonry structures using diagonal struts especially when there are openings and it is not always possible to predict the damaged area of the masonry. Micro-models based on a continuum model can provide an accurate computational representation of both material and geometry aspects, if the properties and the sources of nonlinearity of the masonry are carefully identified, but they are computationally expensive.

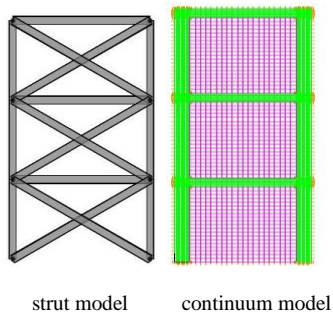

Figure 1 Infill panel models

In this study the strut model has been adopted, where the elastic in-plane stiffness of a masonry infill wall is represented with an equivalent diagonal compression strut of width  $W_{ef}$  given by eq. 1.

$$W_{ef} = 0.175(\lambda_h H)^{-0.4} \sqrt{H^2 + L^2} \quad (1)$$

with  $\lambda_h$  given by :

$$\lambda_h = \sqrt[4]{\frac{E_i t_i \sin 2\theta}{4 E_c I_c H}} \quad (2)$$

where

$E_i$  is the modulus of elasticity of the masonry infill  
 $t_i$  is the thickness of masonry the infill  
 $\theta$  is the angle of the diagonal strut with respect to the beams  
 $E_c I_c$  is the bending stiffness of the column  
 $H$  is the height of the infill panel

To simulate the inelastic response of RC elements under seismic action, two different modelling philosophies are commonly used: the concentrated plasticity and the distributed inelasticity approaches. In the concentrated approach, the inelastic deformations are lumped at the member ends, instead of considering the spread of inelastic deformations along the member length. The most widely nonlinear models used in most analyses are : the one component model and the dual component model.

The one component model which has been first generalized by (Gibson 1967) has been developed on the assumption that inelastic deformations concentrate at some critical locations. A major feature of the model is that inelastic member-end deformation is assumed to depend only on the moment at the end. The model consists of a flexible line with one rotational spring at its end and two rigid zones outside of the rotational spring.

The dual component which has been first introduced by (Clough 1966) assumes that every member consists of two components, an elasto-plastic component which simulates the yielding phenomenon and a completely elastic one which represents the strain hardening acting in parallel. The sum of the two results in a bilinear moment-curvature relationship for the member. The stiffness of the second component  $pEI$  is a specified fraction of the total stiffness and corresponds to the second slope of the bilinear moment-curvature relationship. In practice  $p$  is taken as equal to 0.05. The limitations of the concentrated plasticity models are discussed in (Charney and Bertero 1982), and (Bertero *et al.* 1984).

The distributed inelasticity describes more accurately the continuous structural characteristics of reinforced concrete members, requiring simply geometrical and material characteristics as input data, figure 2. The constitutive behaviour of the cross-section can be either formulated according to the classical plasticity theory in terms of stress and strain resultants, or explicitly derived by discretising the cross section into fibres. The latter approach known as fibre modelling represents the spread of material inelasticity both along the member length and across the section area, which permits an accurate estimation of the structural damage distribution even in the highly inelastic range. Further details concerning this approach can be found in (Kaba and Mahin 1984), (Zeris and Mahin 1991). This model has been adopted in this study.

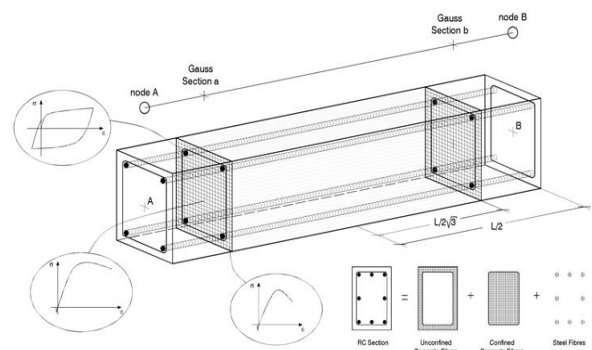

Figure 2 Fiber model for RC members

**3.0 NONLINEAR ANALYSES**

Since we are interested in obtaining the capacities of the structure, it is essential to recourse to an incremental dynamic analysis (IDA). In this method, the structure is subjected to a series of nonlinear time-history analysis of increasing intensity (peak ground acceleration is incrementally scaled from a low elastic response value up to the attainment of a pre-defined post-yield target limit state). The results of an IDA can be visualized through an IDA envelope curve, which consists of a plot of peak values of base shear versus maximum values of top, or other, displacement, as obtained in each of the dynamic runs. The free seismic analysis code, SEIISMO-STRUCT, has been used in all analyses.

**4.0 DESCRIPTION OF THE STRUCTURES**

Three reinforced concrete building with two, four and eight storey have been used in this study. To assess the influence of the masonry infills, two structural configurations have been used: totally and partially infilled frames. The reinforcement of the beams and columns was determined according to the Algerian seismic code, (RPA 2003)

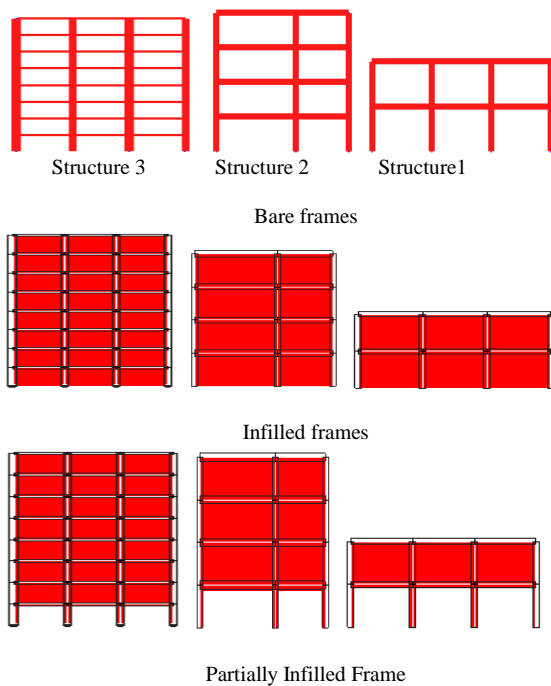

Figure 3 Structures used in the study

The material properties adopted in this study are shown in table1.

Table 1 Material properties

material	Modulus of elasticity (KN/m <sup>2</sup> )	Compressive strength (KN/m <sup>2</sup> )
concrete	32000000	25000
masonry	1100000	1000

**5.0 GROUND MOTIONS**

The accelerograms used in this investigation are the horizontal components of the Dar El Beida ,Chenoua and Hussein Dey

records (Boumerdes 2003), figure. 4. These records are believed to be representative of a strong earthquake in Algeria. The duration of the earthquake used in this analysis was primarily limited to the first fifteen seconds of the earthquake. The peak ground acceleration of the horizontal component of Dar El Beidha is 0.499 g, that of Chenoua is 0.213 and that of Hussein Dey is 0.25 g

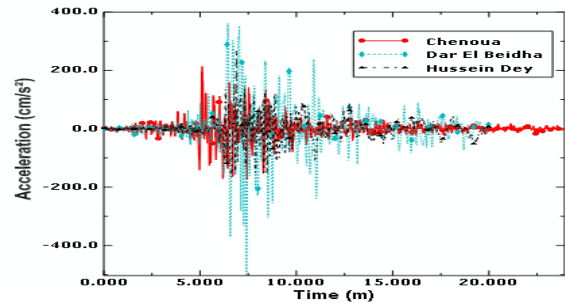

Figure 4. Earthquake records

**6.0 RESULTS AND DISCUSSIONS**

A series on incremental dynamic analyses have been conducted on the three structures under the three earthquakes records. The results obtained in terms of IDA curves are shown in figures 5-12

For structure 1, the strength capacity of totally infilled frames is increased compared to that of the bare frame by a factor of 3.24, 5.65 and 5.8 for the Dar El Beidha, Hussein Dey and Chenoua earthquake records, suggesting an influence of the frequency content of the earthquake, see figures 5,6 and 7..

For the partially infilled frame, the curve in the elastic range follows that of the totally infilled frame but its strength capacity is reduced. The ductility of infilled frames is greatly reduced compared to that of the bare frame

The presence of masonry infill panels reduces considerably the global lateral displacement of the frames.

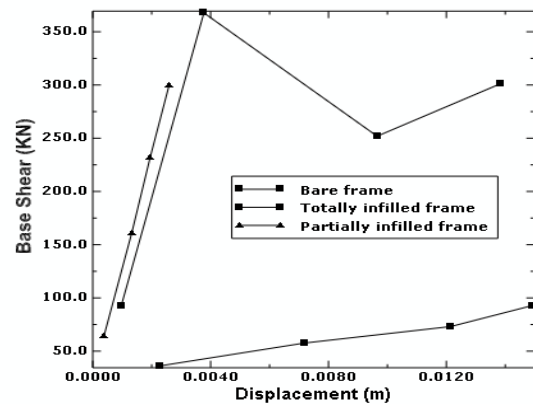

Figure 5 IDA curve structure 1 Dar El Beidha record

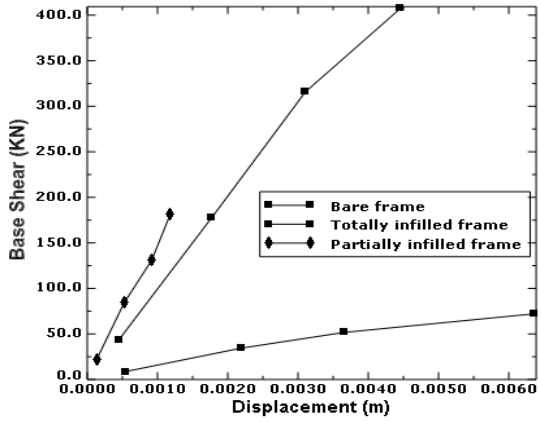

Figure 6 IDA curve structure 1 Hussein dey a record

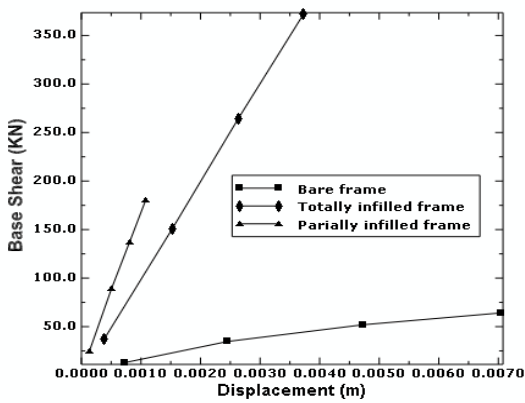

Figure 7 IDA curve structure 1 Chenoua record

For structure 2, the factor of increase of strength capacity when the frame is totally infilled is equal to 3.67, 5.65, and 6.39 for the Dar El Beidha, Hussein Dey and Chenoua earthquake records respectively. These results are comparable to those of structure 1 since the dynamic characteristics of the two structures were found to be close.

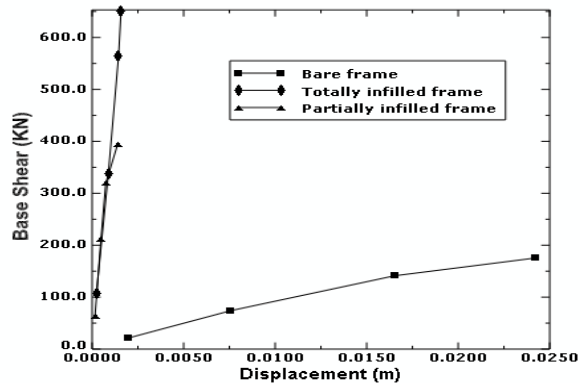

Figure 8 IDA curve structure 2 Dar El Beidha record

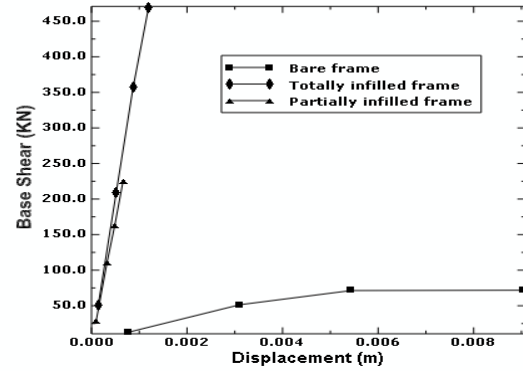

Figure 9 IDA curve structure 2 Hussein Dey record

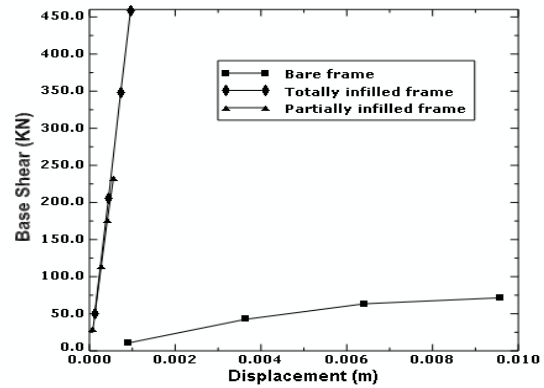

Figure 10 IDA curve structure 2 Chenoua record

For structure 3, the strength capacity of totally infilled frames is increased compared to that of the bare frame by a factor of 3.16, 4.72 and 4.84 for the Dar El Beidha, Hussein Dey and Chenoua earthquake records, indicating an influence of the dynamic characteristics of the structures., see figures 11,12 and 13. For the partially infilled frame, the curve in the elastic range follows that of the totally infilled frame but its strength capacity is reduced. The ductility of infilled frames is greatly reduced compared to that of the bare frame.

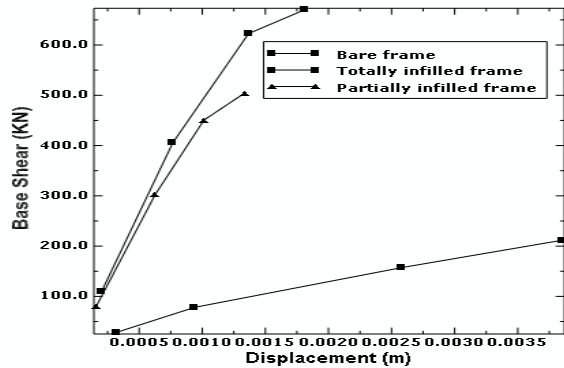

Figure 11 IDA curve structure 3 Dar El Beidha record

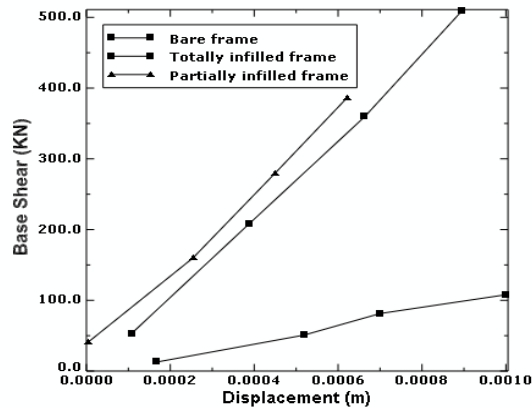

Figure 12 IDA curve structure 3 Hussein Dey record

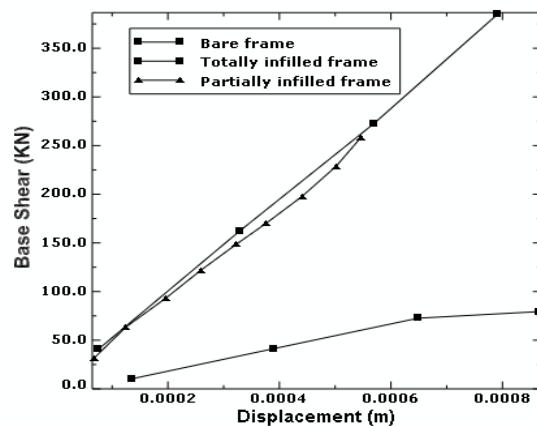

Figure 13 IDA curve structure 3 Chenoua record

## 7.0 CONCLUSIONS

In this study the seismic assessment of reinforced concrete frames with and without masonry infills has been numerically investigated through a non linear analysis. The results of the incremental dynamic analysis show an increase in the initial stiffness, strength of the infilled frame compared to the bare frame. To assess the seismic response of reinforced concrete frames it is advised to consider the contribution of the masonry infill panels. Regular configurations of masonry infill panels have beneficial effect on the global seismic behavior of infilled frame structures and tend to reduce drastically the global lateral displacement. The strength capacity of partially infilled frames is reduced due to the formation of the so called soft story mechanism. The macro modeling using struts can capture the global behavior of infilled frames and does not permit detailed study of local effects

## References

- [1] Asteris, P. G. 2003. Lateral Stiffness of Brick Masonry Infilled Plane Frames. *J.Struct.Eng.* 129(8):1071–1079.
- [2] Buonopane, S. G., and White, R. N. 1999. Pseudo Dynamic Testing of Masonry-infilled Reinforced Concrete Frame. *J.Struct.Eng.* 125(6): 578–589.
- [3] Dhanasekar, M. and Page, A. W. 1986. Influence of Brick Masonry Infill Propriety on the Behavior of Infilled Frames. *Proc. Instn. Civ. Engrs.* London, Part 2, 81: 593–605.
- [4] Liauw, T. C. and Kwan, K. H. 1984. Nonlinear Behaviour of Non-Integral Infilled Frames. *Comp. and Struct. J. Eng.Mech.* 123(7): 660–668.
- [5] Mehrabi, A. B., Shing, P. B., Schuller, M. and Noland, J. 1996. Experimental Evaluation of Masonry-infilled RC Frames. *J. Struct. Eng.* 122(3): 228–237.
- [6] Moghaddam, H. A. 2004. Lateral Load Behavior of Masonry Infilled Steel Frames with Repair and Retrofit. *J. Struct. Eng.* 130(1): 56–63.
- [7] Page, A. W., Kleeman, P. W. and Dhanaseker, M. 1985. An in-plane finite element model for brick masonry. *New Analysis Techniques for Structural Masonry, Proc. Of a session held in conjunction with Structures Congress.* Chicago, Illinois, ASCE, 1–18.
- [8] Saneinejad, A. and Hoobs, B. 1995. Inelastic Design of In-filled Frames. *J. Struct. Eng.* 121(4): 634–650.
- [9] Santhi, M. H., Knight, G. M. S., Muthumani, K. 2005. Evaluation of Seismic Response of Soft-storey Infilled Frames. *Computers and Concrete.* 2(6): 423–437.
- [10] Smith, B. S. 1996. Behavior of Square Infilled Frames. *J. Struct. Div.* ASCE, STI, 381–403.
- [11] Smith, B. S. and Carter, C. 1969. A Method of Analysis for Infilled Frames. *Proc., Instn. Civ. Engrs.* 44: 31–48.
- [12] Kaba, S., and Mahin, S. A. 1984. Refined Modelling of Reinforced Concrete Columns for Seismic Analysis. EERC Report 84/03, Earthquake Engrg. Research Centre, University of California, Berkeley.
- [13] Zeris, C. A., and Mahin, S. A. 1991. Behaviour of Reinforced Concrete Structures Subjected to Biaxial Excitation. *J. of Structural Engrg.* ASCE, 117 (ST9), 2657–2673.
- [14] RPA 2003, DTR, Algeria, 2003. Seisimosoft, Seismo-Struct. 2008. A Computer Program for Static and Dynamic nonlinear analysis of framed structures. on line, available from URL. <http://www.seisimosoft.com>.
- [15] Page, A. W., Kleeman, P. W. and Dhanaseker, M. 1985. An In-plane Finite Element Model for Brick Masonry. *New Analysis Techniques for Structural Masonry, Proc. Of a session held in conjunction with Structures Congress, Chicago, Illinois, ASCE,* 1–18.
- [16] Saneinejad, A. and Hoobs, B. 1995. Inelastic Design of in-filled Frames. *J. Struct. Eng.* 121(4): 634–650.
- [17] Santhi, M. H., Knight, G. M. S., Muthumani, K. 2005. Evaluation of Seismic Response of Soft-storey Infilled Frames. *Computers and Concrete.* 2(6): 423–437.
- [18] Smith, B. S. 1996. Behavior of Square Infilled Frames. *J. Struct. Div.* ASCE, STI, 381–403.
- [19] Smith, B. S. and Carter, C. 1969. A Method of Analysis for Infilled Frames. *Proc., Instn. Civ. Engrs.* 44: 31–48.
- [20] Giberson, M. F. 1967. The Response of Nonlinear Multi-storey Structures Subjected to Earthquake Excitation. PhD thesis, Pasadena, California Institute of Technology, 232 pages.
- [21] Clough, R. W. 1966. The Effect of Stiffness Degradation on Earthquake Ductility Requirements. Report N66-16, Structural Engineering Laboratory, University of California, Berkeley, California
- [22] Charney, F., and Bertero, V. V. 1982. An Evaluation of the Design and Analytical Seismic Response of a Seven Storey Reinforced Concrete Frame Wall Structure. EERC Report 82/08, Earthquake Engrg. Research Centre, University of California Berkeley.
- [23] Bertero, V. V., Aktan, A., Cherney, F., and Suase, R. 1984. Earthquake Simulator Tests and Associated Experimental, Analytical and Correlation Studies on One-Fifth Scale Model. In *Earthquake Effects on Reinforced Concrete Structures*, American Concrete Institute, SP-84-13, Detroit, 375–424.
- [24] Kaba, S., and Mahin, S. A. 1984. Refined Modelling of Reinforced Concrete Columns for Seismic Analysis. EERC Report 84/03, Earthquake Engrg. Research Centre, University of California, Berkeley.
- [25] Zeris, C. A., and Mahin, S. A. 1991. Behaviour of Reinforced Concrete Structures Subjected to Biaxial Excitation. *J. of Structural Engrg.* ASCE, 117 (ST9), 2657–2673.