

Film Cooling Effectiveness in a Gas Turbine Engine: A Review

Ehsan Kianpour^{a,b}, Nor Azwadi Che Sidik^{b,*}, Iman Golshokouh^c

^aFaculty of Engineering, Islamic Azad University of Najaf Abad, Esfahan, Iran

^bThermo-fluid Department, Faculty of Mechanical Engineering, Universiti Teknologi Malaysia, 81310 UTM Johor Bahru, Johor Malaysia

^cFaculty of Mechanical Engineering, Islamic Azad University of Izeh, Khuzestan, Iran

*Corresponding author: azwadi@fkm.utm.my

Article history

Received 17 June 2013
Received in revised form 4 Sep 2014
Accepted 4 Sep 2014

Graphical abstract

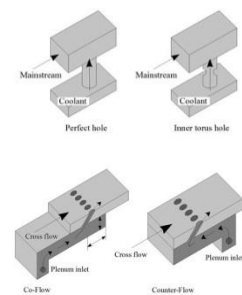

Abstract

This study was carried out to extend database knowledge about the function of film cooling holes at the end of combustor and the inlet of turbine. Using the well-known Brayton cycle, raising the turbine inlet temperature is the key to obtain higher engine efficiency in gas turbine engines. However, high temperature of the combustor exit flow causes non-uniformities. These non-uniformities lead to the reduction of expected life of critical components. Therefore, an appropriate cooling technique should be designed to protect these parts. Film cooling is one of the most effective external cooling methods. Various film cooling techniques presented in the literature have been investigated. Moreover, challenges and future directions of film cooling techniques have been reviewed and presented in this paper. The aim of this review is to summarize recent development in research on film cooling techniques and attempt to identify some challenging issues that need to be solved for future research.

Keywords: Gas turbine; film-cooling; trenched holes; shaped holes; compound holes

© 2014 Penerbit UTM Press. All rights reserved.

Nomenclature

A_{jet}	Area of cooling jet	T_{∞}	Temperature of mainstream
C_d	Discharge coefficient	u	Velocity in x direction
C_p	Specific heat	u_{jet}	Velocity of cooling jet
d	Trench depth	u_{∞}	Velocity of mainstream
D	Film-cooling hole diameter	U	Dimensionless velocity in x direction
g	Gravitational acceleration	v	Velocity in y direction
H_{in}	Combustor inlet height	V	Dimensionless velocity in y direction
I	Momentum flux ratio	w	Velocity in z direction
k	Thermal conductivity	W	Combustor width
L	Combustor length	W_T	Trench width
\dot{m}	Mass flow rate	x	Stream-wise distance
N	Number of film-cooling holes	X	Dimensionless stream-wise distance
p	Pressure	y	Pitch-wise distance
Pr	Prandtl number	Y	Dimensionless pitch-wise distance
P_0	Total pressure	z	Span-wise (vertical) distance
P_s	Static pressure	Z	Dimensionless span-wise (vertical) distance
q	Heat flux		
Ra	Rayleigh number		
t	Time		
T	Local temperature		
T_c	Temperature of coolant		

Greek Symbols

α	Thermal diffusivity
β	Volumetric thermal expansion coefficient
Γ	Diffusion coefficient
δ	Height of constriction

θ	Dimensionless temperature
μ	Dynamic viscosity
ν	Kinematic viscosity
ρ	Density
ρ_{jet}	Density of cooling jet
ρ_{∞}	Density of mainstream
τ	Viscous stress
σ	Tangential velocity
ϕ	General variable

1.0 INTRODUCTION

Gas turbine industries are seeking for better performance and enhancing power to weight ratio. Brayton cycle seems to be an appropriate option for this purpose. In this cycle, the outlet temperature of combustor or the inlet temperature of turbine must be increased to enhance the performance of gas turbine engine [1,2]. According to Thole and Knost [3], the operating temperature is such above that all materials cannot resist against this value of temperature. Also, running hot gases inside the combustor and at the inlet of the turbine has very destructive effects on the downstream components (Figure 1). To prevent these problems, a number of researchers have adopted film cooling as a solution and have attempted to increase film cooling effectiveness to produce better conditions downstream the combustion chamber. A cooling technique must be applied to prevent the thermal degradation of turbine components. Primary gas turbine engines are operated at a temperature range between 1200 °C and 1500 °C, but modern engines functioned at the combustor outlet temperature between 1950 °C and 2010 °C [4]. However, with new schemes of cooling used since the beginning of the 21st century, the turbine inlet temperature increased above 2000 °C. Accordingly, restructuring the cooling holes could improve film cooling effectiveness.

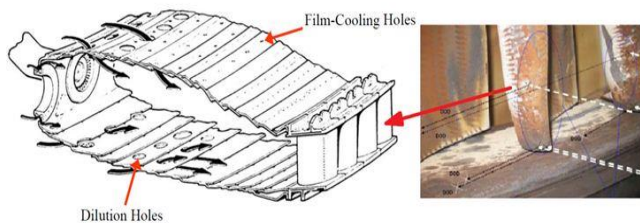

Figure 1 Schematic of annular combustor and the turbine first vane damage [2]

External and internal cooling systems are two methods of cooling gas turbine. In the internal cooling, the compressor prepares the coolant and it is then forced into the cooling flow circuits within the turbine parts. In another cooling system (external cooling), downstream parts are saved against hot gases by the injection of the coolant from the coolant manifold. In this method, heat transfer from hot gases to different components is quelled by the application of coolant. The most effective method of external cooling preservation is film-cooling. In this technique, a thin and low temperature boundary layer is developed by cooling holes and is attached on the protected surface (Figure 2).

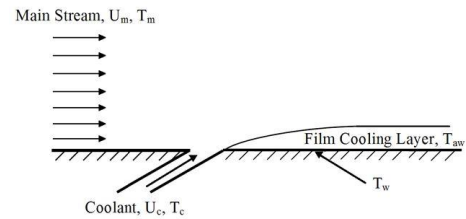

Figure 2 Schematic of film cooling

Since numerous studies have been done on the effects of coolant blowing ratio and other dynamic or thermodynamic parameters on film cooling performance, to get an in-depth idea on restricting of cooling holes, a broad literature survey has been conducted on previously applied configuration of cooling holes, their effectiveness and the increment with surface structure before starting the restructuring procedure [5,6]. The next chapter discusses the effects of flow characteristics variations on cooling performance, as well as the effects of different structures of cooling holes on film cooling effectiveness.

2.0 TRADITIONAL COOLING HOLES

Cylindrical cooling holes are a common form of cooling holes. As illustrated in Figure 3, in this type of cooling holes, the coolant runs through the holes and spreads into the main flow with stream-wise angle of α from the horizontal surface. The change of geometrical parameters of such holes is a topic that has interested researchers for many years.

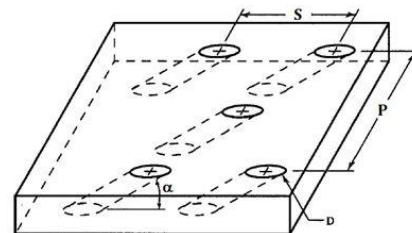

Figure 3 A schematic view of traditional cooling holes

Scheepers and Morris [7] conducted an experimental study to investigate the heat transfer for the inlet of injection holes within a turbine blade cooling passage. To validate the experimental results, they simulated a CFD model with a RNG $k-\epsilon$ turbulence model. The results indicated that at higher suction rate, the quantity of heat efficiency increased with the observed extraction degree of 150 was less than ninety- degrees extraction hole. At suction ratio of 5, a 45 percent decrease in increment was observed near the hole, while 25 percent decrement was observed at $SR=2.5$.

Harrington *et al.* [8] presented a simulated flat plate. The research was a computational and experimental one aimed at investigating a full coverage of adiabatic film cooling effectiveness. The focus of the findings was on the effects of ten rows of normal short cooling holes with a length of $l/D = 1.0$ at large density coolant jets and high mainstream turbulence intensity. The test results indicated that considering the blowing ratio, the maximum adiabatic film cooling effectiveness was attained near the area, which covered four to eight rows of cooling

holes. Furthermore, the interaction of injected flows sprayed from the cooling rows limits the maximum effectiveness. On the other hand, film cooling effectiveness on the curved surface was investigated numerically by Koc *et al.* [9]. They highlighted that the curvature of the surface and the blowing ratio affect the film cooling effectiveness.

Yuzhen *et al.* [10] detected the effectiveness of film cooling of three various multi-hole designs. In the research, they examined the effects of spacing between cooling row, span-wise hole pitch and the hole inclination angle. The results showed that the row spacing ratio affects the film cooling performance. Also, better adiabatic cooling performance is achieved using a smaller pitch, especially for the multi-hole patterns. Ai and Fletcher [11], Cun-liang *et al.* [12] and Jun Yu and Shun [13] studied the similar case and determined that the effectiveness at locations close to the exit of jets for wide hole spacing is slightly higher than for small hole spacing. Meanwhile, the small hole spacing performed better than wide hole spacing at downstream locations due to the interaction of neighboring jets.

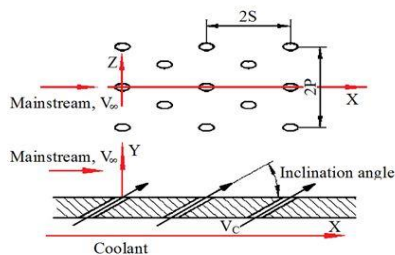

Figure 4 Schematic of film cooling

Abdullah and Funazaki [14] studied the effects of different hole angles. They studied four rows of different inclined holes with two different angles of 20 degrees and 35 degrees. They prepared contours which showed the distribution of laterally averaged film cooling effectiveness and film cooling performance at x/D equal to 3, 13, 23 and 33. The results showed that at a higher blowing ratio ($BR = 3.0$ and 4.0), the interaction between the neighboring secondary air led to a full coverage film cooling effectiveness downstream of the fourth row, which was confirmed by the temperature field captured at $x/D = 33$ and $BR=4.0$. The results also showed that more cooling effectiveness was achieved at a shallow hole angle of $\alpha=20$ degrees, especially at higher blowing ratios compared to a baseline case with a hole angle of $\alpha=35$ degrees. Sarkar and Bose [15] displayed that the usage of cooling holes with elevated injection angles developed turbulence, and higher turbulence led to the reduction of cooling performance. Furthermore, Nasir *et al.* [16], Shine *et al.* [17] and Hale *et al.* [18] simulated a flat plate with cylindrical cooling holes to study the effects of injection angle on the effectiveness of film cooling. They highlighted that lower stream-wise injection angles perform better by producing a higher film cooling effectiveness.

The effects of different imperfection on film cooling and arrangements of small holes on the jets cross flow were studied by Jovanovic *et al.* [19,20] with the application of PIV and LCT techniques. The results showed that at moderate velocity ratios, the effectiveness of inner-torus decreased significantly and narrowed the cooled area. At larger velocity ratios, an influence of the inner-torus almost vanished. The imperfection located 2.5 diameters inside the hole did not have any significant influence on the film cooling effectiveness. The free stream turbulence was changed by means of using static grid. The turbulence intensity was increased from 1% to 7%. The adiabatic effectiveness was weakly affected by the turbulence intensity. Only in the vicinity of

the maximum effectiveness for the inner-torus, the effectiveness was reduced for about 10%.

Multiple jets placed inside cross flow were used by Peterson and Plesniak [21] to analyze the effects of velocity. They investigated the effects of plenum flow direction, injection angle, as well as blowing ratio. Consistent with the research by Plesniak [22], the findings indicated that a light and less integrated counter-rotating vortex pair (CRVP) is developed because of the vortices spawn inside injection hole and opposite rotation direction, which is opposite to the CRVP rotational sense with the application of the counter-flow plenum. Compared to counter flow case, co-flow plenum increased the trajectory and reduced span-wise injection. Furthermore, Nakabe *et al.* [23] debated that jet impingement is effective for heat transfer augmentation even in the case with cross flow.

Hale *et al.* [24] measured the effectiveness of surface adiabatic film cooling adjacent to cooling holes. They studied an individual short holes row and narrow plenum. They noticed different kinds of L/D ratios, injection angles, co-flow and counter-flow plenum feed configurations (Figure 5). The findings showed that short injection holes increased the film cooling and developed wide cold region downstream of the cooling holes. Their findings were identical with those of Burd and Simon's [25], as the relevance of the length of injection hole to effectiveness of film cooling could be well understood. In another study, Azzi and Jurban [26] forecasted the film cooling thermal fields for a simulated cylindrical cooling row with the following ratios: extended range of length to diameter = $1.75/8$, and fixed pitch to diameter = 3.0 . The inclination angle was 35 degrees and the film hole was 12.7 mm in diameter. Another finding by Bernsdorf *et al.*, [27], Yong-gang and Qiang [28] and Jumper [29] showed that in short cooling injection holes, effectiveness of film cooling is related to the injection hole length and angle.

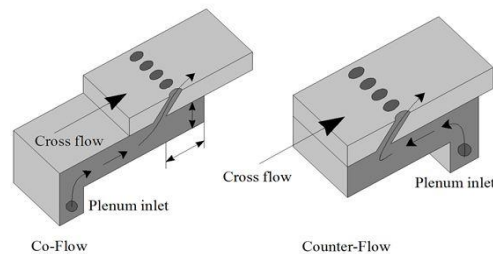

Figure 5 Schematic of adiabatic test section and plenum [24]

In 2012, Saumweber and Schulz [30] stated that an increase of the length of a cylindrical hole in principle, favorably affects cooling effectiveness at plenum conditions at the hole entrance. The experimental results collected by Mohammed and Salman [31] indicated that the ratio of the axial length (L) to the diameter (D) also has an effect on the average heat transfer rate at same conditions.

Nemdili *et al.* [32] conducted a numerical study to determine the interaction of the jet cross flow and the use of imperfection within the turbine blade cooling holes (Figure 6). The results declared that by using imperfection inside the injection hole, the film cooling performance reduces dramatically, whereas the rate of velocity increases. In addition, the results found that cooling performance is reduced dramatically when 50 percent of the injection hole is blocked, and this phenomenon affects the turbine blade protection intensively.

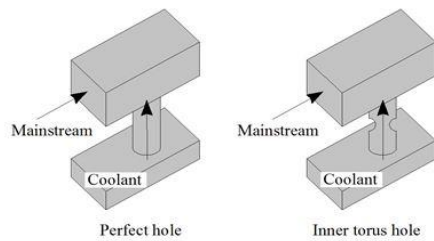

Figure 6 The geometries of the holes (a) hole and (b) Inner torus hole [32]

Li *et al.* [33] and Mee *et al.* [34] studied the effects of distance between two adjacent holes and suction surface of blade on heat transfer. When an elevated distance is seen between two adjacent cooling holes, a cooling film is found among the jet orifices. Also, when the distance between two adjacent holes is small, the jet orifice cooling is better than jet orifice.

Using the application of LCT technique, Nasir *et al.* [35] investigated the effects of separate shaped tabs with a variety of orientations on the film cooling performance from one cylindrical holes row. The results showed that the upward oriented tabs are ineffectual and reduced the film cooling performance. Using horizontal and downward oriented tabs increased heat transfer coefficient, but the increased value of film cooling effectiveness is higher than heat transfer enhancement.

By using the large scale and low speed experiments, Rowbury *et al.* [36,37] determined the effects of flow interaction under the annular cascade application. They investigated the effects of hole geometry on discharge coefficient of coolant. The results declared that near the end of injection hole with external cross flow, the static pressure loss relative to the assumed value led to the discharge coefficient enhancement.

Tarchi *et al.* [38] investigated the effects of large dilution holes. These holes were placed within the injecting slot and eruption array. The flat plate cross section duct contained 270 cooling holes located in 29 staggered rows. The holes were 1.65 mm in diameter and had a length to diameter ratio of 5.5 and a stream-wise angle of 30 degrees. The dilution hole was 18.75 mm in diameter (Figure 7). It was located at the 14th row of cooling holes. Tarchi *et al.* measured the local heat transfer coefficient and adiabatic film cooling effectiveness for both conditions, with and without backward facing step, at three different blowing ratios of BR=3.0, BR=5.0 and BR=7.0. Tarchi *et al.*, Milanese *et al.* [39], Barringer *et al.* [40], Li *et al.* [41] and Scrittore [42] illustrated that by using backward step at downstream the dilution hole, the adiabatic film cooling effectiveness reaches laterally averaged effectiveness of 0.65.

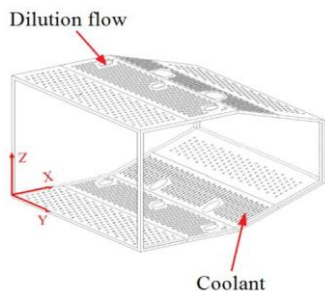

Figure 7 The geometry of the test model

An experimental study was conducted by Cun-liang *et al.* [43,44] to analyze the temperature non-uniformities adjacent the wall surfaces and the console film cooling performance (Figure 8). Within two different console area ratios, the film cooling effectiveness distribution was considered. The results depicted that the low temperature flow which goes out from the console attached to the blade surface and creates better condition for heat transfer. Concurrent with Liu *et al.* [45], Bunker [46] maintained that the effectiveness reduction occurs due to the increase of exit-to-inlet area ratio. In addition, Sargison *et al.* [47] experimentally demonstrated that using converging console on the suction side caused the coolant flux to increase and has no visible effect on the film cooling performance. However, this has been rejected by the Barigozzi *et al.* [48]. Based on their findings, they argued that the exit-to-inlet area ratio increase is a main cause of thermodynamic secondary loss enhancement. They observed the optimum film cooling at higher blowing ratio. Xiangyun *et al.* [49] also stressed that higher hole-opening ratio produces better heat transfer effect. Using several slots in cases like cooling downstream components was studied by Joshua *et al.* [50] and Thrift *et al.* [51]. The results indicated that narrower slot widths decrease spatially-averaged adiabatic effectiveness as the depth reduces by 28%. The reduction of turbulent levels causes the coolant to diffuse at the hole exit and thereby modifies film cooling effectiveness. They also found that film cooling performance is better achieved with longer slots than with short slots. Agreeing with Joshua *et al.* and Thrift *et al.*, Lynch and Thole [52] mentioned that decreasing the slot width while maintaining a constant slot mass flow resulted in larger coolant coverage areas and increased local effectiveness levels. In addition, the cooling effectiveness of the slot with an orientation angle of 45 degrees is higher than that of a 90 degrees slot orientation.

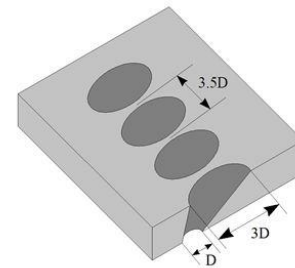

Figure 8 The geometry of the converging slot holes [43]

Vakil and Thole [1] presented experimental results of the study of temperature distribution inside a combustor simulator. In this study, a real large scale of combustor was modeled. This model contained four different cooling panels with many cooling holes. Two rows of dilution jets could be seen in the second and third cooling panels. The first row had three dilution jets and the second one had two jets. While the first and second panels were flat, two other panels angled with an angle of 15.8 degrees. The coolant flow and high momentum dilution jets were spread into the main flow. The results indicated that high temperature gradient was developed upstream of the dilution holes. Kianpour *et al.* [53,54] in 2012, re-simulated the Vakil and Thole's combustor. They suggested two different layouts of cooling holes with different exit section areas. The results indicated that while the central part of the jets stayed nominally at the same temperature level for both configurations, the temperatures adjacent the wall and between the jets was awhile cooler with less cooling holes.

3.0 TRENCHED COOLING HOLES

Another type of cooling holes is trenched hole, which is shown in Figure 9. At the end of this hole, the area is expanded and as a result, coolant is suddenly injected before leaving the cooling hole and beginning the main flow. As indicated by Sundaram and Thole [55] (the research on the effects of a row of individual trenched cooling holes located at the leading edge region along the end wall of a stator vane under low Reynolds number) this restructured hole leads to higher adiabatic effectiveness, especially at elevated blowing ratios.

The effects of improved direction of cooling flow at the vane end-wall were studied by Sundaram and Thole [56] to increase the effectiveness of film cooling. This investigation has been accomplished with three single and row trench depths (d) of $d=0.4D$, $d=0.8D$ and $d=1.2D$ (D is the cooling hole diameter) and some bump heights of 0.5, 0.8 and 1.2 as illustrated in Figure 10. Sundaram and Thole found that the row trench effectiveness was significantly higher than the individual trench. The application of trenched holes with a depth of $0.80D$ provided the best cooling effect. However, Lawson and Thole [57] showed that using the trenched hole with a depth of $0.8D$ led to a negative effect on the performance of cooling system downstream the cooling hole and increased the effectiveness inside the trenched hole. However, when the bump was used, the optimum cooling was found at the bump height of $0.50D$ and $0.80D$.

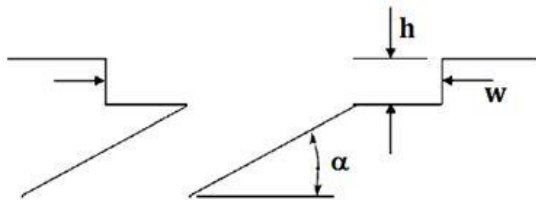

Figure 9 Geometry of trenched hole

Waye and Bogard [58] studied the adiabatic film cooling effects of transverse trenched holes on the suction side. The experiments involved establishing a linear vane cascade within a closed loop wind tunnel. In order to facilitate adiabatic temperature measurements collection, low thermal conductivity polyurethane foam was applied for vane construction. They also used infrared camera and thermocouples to determine the temperature distribution. The results show that the adiabatic film cooling effectiveness was modified by the downstream rectangular lip. The upstream geometry of the trench appeared to only slightly affect the cooling effectiveness. The adiabatic film cooling effectiveness was modified using narrow trench configuration.

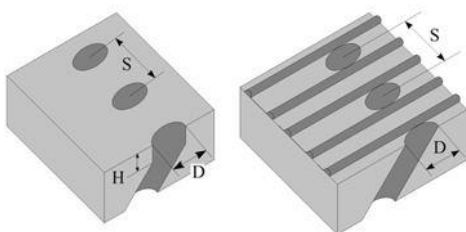

Figure 10 The geometries of the holes (a) Trenched hole and (b) Bump hole [56]

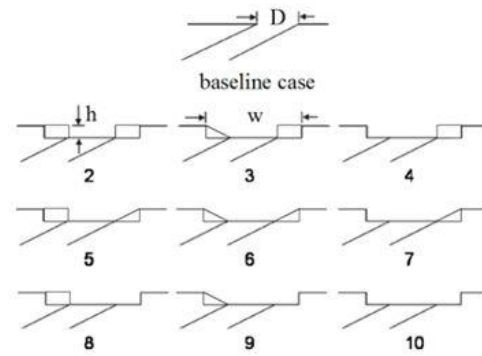

Figure 11 Trench lip configurations [61]

Yiping *et al.* [59] tested the effects of depth and width of trenches at the turbine leading edge on film cooling. A high Re $k-\epsilon$ turbulence model was used in the computational study. They considered six different individual trenched holes arrangements with a width of $w=2D$ and $w=3D$ and depth of $0.5D < d < 1.0D$, as well as cylindrical cooling holes and shaped holes. The findings showed that the third and fourth cases had a trench depth of $d=0.75D$, and it means that the trench depth of $0.75D$ was the optimum one, which is confirmed by CFD studies.

Barigozzi *et al.* [60] surveyed the effectiveness of the upstream trenched holes used on the end wall contours under the extended range of blowing ratios from 0.5 to 2.5. The test model contained two different trench depths ($d=1.0D$ and $1.20D$) and a fixed width of $2D$. The test section containing seven vanes was set up in the low-speed wind tunnel with slight inlet turbulence intensity of 1% and with an isentropic Mach number of 0.2. Furthermore, the inlet area of the wind tunnel was converged with a ratio of 0.70.

Using a turbine vane cascade, the effects of shallow trenched holes ($d=0.5D$) were investigated by Somawardhana and Bogard [61] to improve the performance of film cooling as shown in Figure 11. The film cooling effectiveness was measured for a range of blowing ratios, from $BR=0.4$ to 1.6. The findings indicated that upstream obstructions reduced the effectiveness by 50%. However, downstream obstructions increased the film cooling performance. The film cooling performance was slightly affected by a combination of obstructions near the upstream obstructions. Using a narrow trench, they dramatically modified the cooling performance and reduced the effects of surface roughness decrease. The results agreed with Harrison *et al.* [62] and Shuppig's [6] findings. Furthermore, Somawardhana and Bogard showed higher film cooling effectiveness for the trenched holes which resulted from the net heat flux reduction was higher than the baseline case, while the heat transfer coefficient was approximately constant for both cases. In contrast, Yiping and Ekkad [63] showed that trenching cooling holes increased heat transfer coefficient. Ai *et al.* [64] showed that trenching reduced the coolant momentum ratio and impaired the effectiveness, whereas traditional cooling holes performance was better at low blowing ratios.

4.0 SHAPED COOLING HOLES

Shaped cooling holes is another category of such holes. As illustrated in Figure 12, for this type of hole, the section area of the cooling hole changes through the hole. Although the inlet section area is circular, the exit section changes to a specific shape

such as fan-shaped and diffused-shaped. A significant modification and the use of shaped cooling holes leads to higher cooling performance.

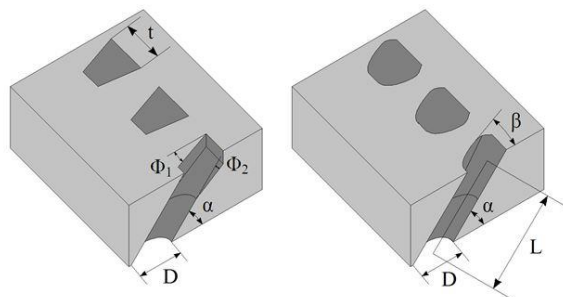

Figure 12 The geometry of shaped holes [65]

Asghar and Hyder [65] computationally studied the film cooling effectiveness for single and two staggered rows of novel semi-circular holes. Their most important finding is the fact that the centerline and lateral effectiveness of the two staggered rows of semi-circular holes are much higher than a single row of full circular hole.

By measuring the concentrating secondary flow variations at different blowing ratios, Barigozzi *et al.* [66,48] experimentally investigated the effects of end wall fan-shaped cooling holes arrangements on the aerodynamic and heat transfer performance. With fan-shaped holes, the highest film cooling effectiveness is achieved due to the injection of massive flow at smaller momentum flux ratio. With cylindrical holes, the maximum cooling was found at mass flux ratio of 0.75%, while the value of this quantity was 1.5 percent for the fan-shaped holes.

Lee and Kim [67,68] studied about a combustor simulator. They selected laidback fan shaped holes which were used in their study to observe the effects of geometric variables improvement on film cooling. They showed that for $BR=0.5$, the optimum injection and lateral expansion angles were 40.34° and 21.83° respectively. At the same time, the best L/D ratio was considered to be 7.45. Later, Lee and Kim [69] verified the results and showed that with the improvement of the optimum shape of cooling holes, the lateral spreading of the cooling flow was modified and the coolant attached better, thereby film cooling performance increased by 28 percent.

Saumweber and Schulz [70] studied the interaction effects between film cooling rows. The test section included five different large scale cooling holes. They studied fan-shaped and cylindrical holes with an angle of 30 degrees from the horizontal axis and some spacing between cooling holes with $x/D = 10, 20$ and 30 and hole length of $L/D = 6.0$. The results indicated the following: a) the geometry of the second row of the cooling holes has significant effects on cooling, however, b) the row spacing between cooling jets is not significant in the performance of film cooling because of simultaneous increase of the heat transfer coefficient and film cooling performance (Figure 13).

By using a new turbulent model, Zhang and Hassan [71] studied the effects of jet-in-cross flow of new scheme on the cooling performance. They find out that with the new scheme, the heat transfer coefficient reduced near the centerline of the shaped holes in comparison with the cylindrical case and as a result, film

cooling effectiveness was higher for the shaped cooling holes compared to the baseline case (Gao *et al.* [72]; Colban *et al.* [73]). In addition, Saumweber *et al.* [74], Saumweber and Schulz [75], Barigozzi *et al.* [76], Fawcett *et al.* [77] and Peng and Jiang [78] showed that for shaped holes, a better thermal protection capability is achieved, especially at higher blowing ratios. Bayraktar and Yilmaz [79] numerically developed a three-dimensional model to study the film cooling performance. Circular and square shaped multiple nozzle geometries were considered. The main finding was that using circular multiple nozzles lead to higher thermal film cooling effectiveness than that of square shaped multiple nozzles.

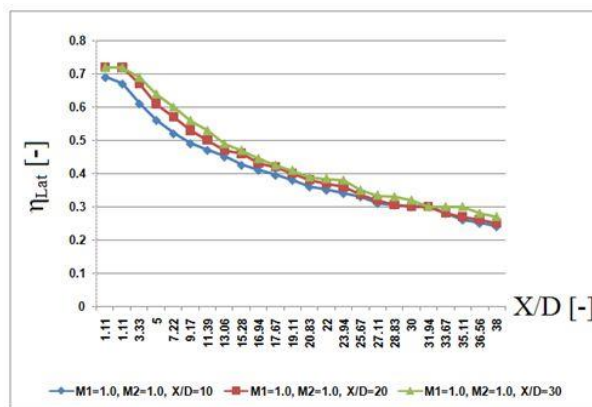

Figure 13 The effect of row spacing on adiabatic film cooling effectiveness [70]

Zhang *et al.* [80] studied the heat transfer of flow on flat plate, which includes cone-shaped and round-shaped cooling holes. In the study, numerical simulations based on control volume method and RNG $k-\epsilon$ turbulence model were performed to investigate the flow and heat transfer characteristics of the flat plate film cooling. The results showed that at the same blowing ratio, the film cooling effectiveness for the cone-shaped holes was better than the round-shaped holes. For cone-shaped jets, the jet-to-cross flow blowing ratio reached the optimum condition of 1.0 to yield the best film cooling effectiveness.

Colban *et al.* [81] again presented experimental results to compare the effects of several fan-shaped cooling holes rows and one single row of cooling holes in the same location of pressure and suction surfaces on adiabatic film cooling effectiveness. The actual physical behavior of flow was better predicted by v^2-f turbulent model, while the most accurate match between computational and experimental results was attained using the RNG $k-\epsilon$ turbulent model (Figure 14). Similar to Colban *et al.* [82], it is determined that both surface distance and blowing ratio increased film cooling effectiveness on pressure surface.

Colban and Thole [83] and Saumweber and Schulz [30] investigated the effects of two different cooling holes, which are cylindrical and shaped holes configurations, on the cooling performance and aerodynamic penalties. The findings showed that the quantity of total pressure wastage is much less with fan-shaped holes than cylindrical ones. For fan-shaped holes, the coolant is attached to the wall surface which, as a result, increases the coolant flow blowing ratio. Concerning aerodynamic penalties, fan-shaped holes play a better role than cylindrical holes.

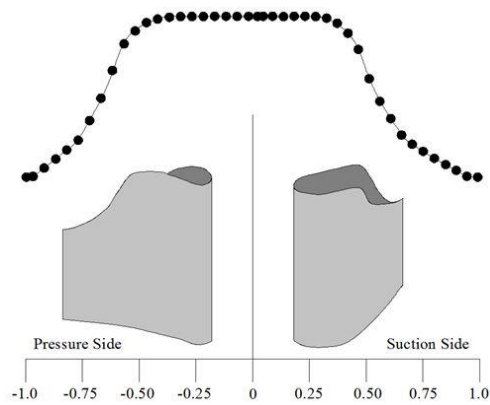

Figure 14 Contoured end-wall surface definition [81]

5.0 COMPOUND COOLING HOLES

In a traditional cooling hole, the flow runs within a cooling hole and is injected in the stream-wise direction with an angle of ϕ from the horizontal surface. Figure 15 shows an example compound hole. For this type of holes, the flow spreads in the span-wise direction at an angle of γ .

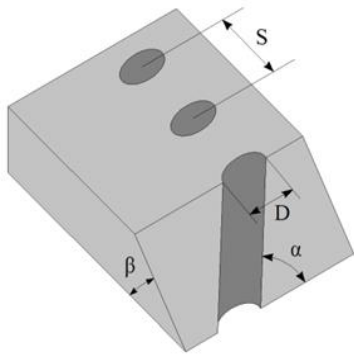

Figure 15 The geometry of compound cooling holes [84]

Sang *et al.* [84] determined the thermal field at the aft position of a row of compound injection holes under different orientation angles and blowing ratios. The results showed that a uniform span-wise field was provided by the orientation angle increment and improved the film cooling. Furthermore, the compound angle holes effects were more considerable, particularly at an orientation angle of above $\gamma=60$ degrees and a blowing ratio higher than $BR=1$.

Gritsch *et al.* [85] took discharge coefficient measurements of traditional injection holes at inclination angles of 30, 45 and 90 degrees and orientation angles of 0, 45 and 90 degrees. The results indicated that the orientation or inclination angle variation has dominant effects on the losses at the inlet of holes. The increase of the orientation or inclination angle is a reason for the enhancement of losses at the inlet of cooling holes. It can also be the reason for the discharge coefficient reduction. At the end of injection holes, the inclination or orientation angle enhancement is the moderate cause of flow loss.

Aga and Abhari [86] investigated the effects of lateral angle, blowing and density ratios on the blade leading edge film cooling.

In accordance with Jubran *et al.* [87] and Han *et al.* [88], Lee *et al.* [89] argued that at elevated compound angles of 60 and 90 degrees, averaged adiabatic film cooling effectiveness is twice as much the stream-wise injection, particularly at elevated blowing ratios. In addition, high compound angles increment raised the jet free stream interaction and, therefore, enhanced the normalized heat transfer coefficient. Nasir *et al.* [16] and Aga *et al.* [90] clarified that compound angle holes increment affects heat transfer, and the film cooling effectiveness is illustrated in Figure 16.

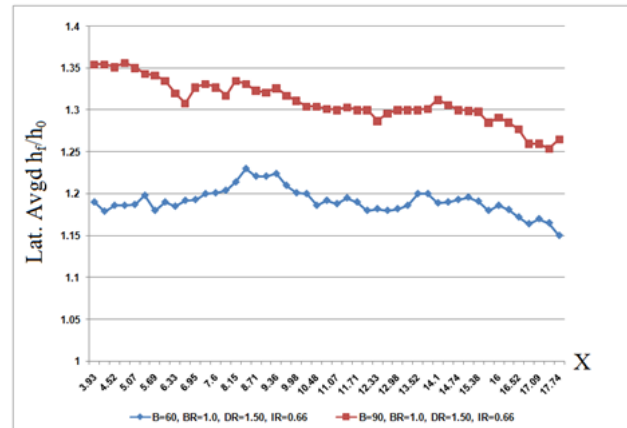

Figure 16 Laterally averaged heat transfer augmentation [90]

Jung and Young [91] detected that the highest film cooling effectiveness was attained at the middle ($z/D=0$) for a compound angle of 0 degrees, and the maximum film cooling effectiveness was detected on the right side of the vortex for a compound angle of 60 degrees.

Stitzel and Thole [92] studied the effects of geometrical combustor parameters on the flow and thermal field downstream the combustion chamber. The test section contained three different configurations, (a) film cooling and dilution jets, (b) film cooling, dilution holes and slot at the combustor-vane interface, and finally (c) film cooling with cooling holes that were oriented with a compound angle of 45 degrees and an inclination angle of 30 degrees, dilution holes and exit slot. The results indicated that the application of compound angle holes enhanced the total pressure.

Jurban and Maiteh [93] showed the effects of two staggered rows of cooling holes on film cooling effectiveness and heat transfer. The primary design includes a combination of one row of simple holes and one row of compound holes, whereas the second one consists of two rows of compound cooling holes. According to Jurban and Maiteh, the maximum film cooling effectiveness is yielded by the application of the staggered compound holes, which is much better than the inline compound angle holes and simple angle holes. This is confirmed by Maiteh and Jubran [94] as well. Figure 17 depicts that the two staggered rows arrangement of compound angle injection holes tends to provide a better and more uniform cooling protection than that of the two inline rows of compound angle injection holes.

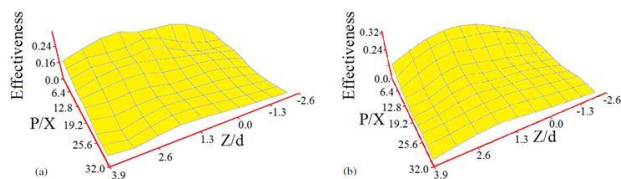

Figure 17 Three-dimensional cooling effectiveness (a) inline compound hole and (b) staggered compound hole [94]

By applying TDM (three-dimensional volume methods) and multi block techniques, Azzi and Jurban [95] studied the effects of different lateral angles on adiabatic film cooling effectiveness. They detected that at an inclined injection angle of 25 degrees, better film cooling performance was yielded.

Zhang and Wen [96] conducted a computational study on flow behavior in different parts of a stationary gas turbine vane at a blowing ratio of 1.50 and compound holes application at the leading edge using LES. The results showed that suitable arrangement of compound angle holes creates suitable condition to have the best cooling at both pressure and suction sides of turbine vane. On the pressure surface, the central part of vortex is away from the blade wall. In addition, the area influence of vortex is noticeable. Lin and Shih [97] and Wright *et al.* [98] showed that a combination of half wake vortices, half wall vortices, horseshoe vortices and a pair of counter rotating vortices is developed due to the reciprocity among mainstream flow, which is seen in stream-wise flow fields and coolant. This is shown in in Figure 18. Han *et al.* [99] believed that vortices can be produced by shear stress, momentum exchange of cooling ejection and mainstream flow.

Shine *et al.* [100] investigated the effects of different coolants as the length of cooling holes and the uniformity of film cooling depend on the liquid or gaseous coolants. The results showed that at low blowing ratios, there was no difference between the effects of different coolants on cooling. At high blowing ratios, the compound angle has a noticeable effect on cooling in comparison to non-compound hole cases. The maximum film cooling effectiveness was achieved at compound angles of 10° - 30° , while the effect of compound angles of 10° - 45° was not remarkable. According to Al-Hamadi *et al.* [101], the compound angle holes results of the averaged film cooling effectiveness downstream of the injection rows suggest that compound angle rows tend to give better protection than those obtained by simple angle holes.

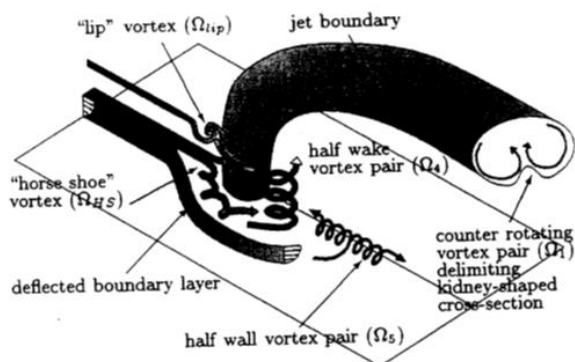

Figure 18 The schematic view of the vortical structures in the jet cross flow interaction [98]

■6.0 TRENCHED SHAPED COOLING HOLES

Trenched shaped cooling hole is constructed from a combination of both trench and shaped geometries of holes as shown in Figure 19. In fact, as the section area of the hole is varied from the inlet to the exit, the area of the hole is expanded at the exit section and the flow is suddenly spread at this zone as well.

Using cylindrical, forward diffused, trenched forward diffused, conically flared, trenched conically flared, laterally diffused and trenched laterally diffused shaped holes, Baheri Islami *et al.* [102] gain studied the effects of cooling holes on the film cooling effectiveness at the leading edge of turbine blade. The results of this research indicated that for all of the above configurations, span-wise, centerline and laterally averaged film cooling effectiveness was increased by trenching the holes. However, the most effective application of trench was detected for the forward diffused shaped holes. Overall, the film cooling effectiveness of shaped holes and trenched shaped holes was higher in comparison with other configurations, although Baheri Islami and Jubran [103] showed that the best film cooling effectiveness was attained for the trenched holes at all blowing ratios.

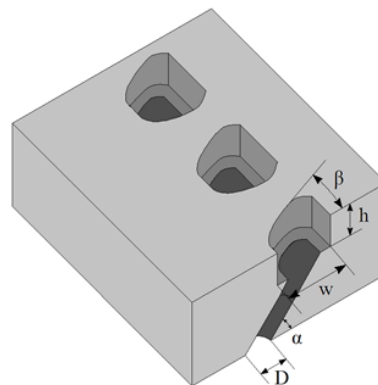

Figure 19 The geometry of trenched shaped cooling hole [102]

In the paper by Baheri Islami *et al.* [104], they discussed the effects of four different film cooling configurations – cylindrical hole, trenched cylindrical hole, shaped hole and trenched shaped hole – on film cooling performance. Their findings showed that an obstacle is created in front of the coolant flow at the downstream of the trenched holes. Therefore, the coolant flow is angled laterally along the hot surface and stands near the hot surface. The blockage will finally cause the vortex motion of the cooling jet to decrease and to strongly pull the hot gases. As a result, film cooling effectiveness is improved for the trenched holes.

■7.0 COMPOUND SHAPED COOLING HOLES

As can be seen in Figure 20, compound shaped cooling hole contains a combination of two other mentioned types of holes – the compound and the shaped one. In fact, the section area of the hole changes from the beginning to the end and then it is injected along the stream and span-wise direction.

By applying the PSP method, Gao *et al.* [105,106] investigated the effects of different specifications of compound angle laid back fan-shaped holes on film cooling performance for a HPT (high pressure turbine). The primary findings of the study showed that over a wide part of blade's suction surface, a uniform coolant was formed using the laidback fan-shaped holes with compound angles. Compound shaped holes produced higher film cooling effectiveness in comparison with compound cylindrical

cooling holes, particularly for both suction and pressure sides and at elevated blowing ratios. This is in agreement with previous studies by Hong-Wook Lee *et al.* [107] and Mhetras *et al.* [108].

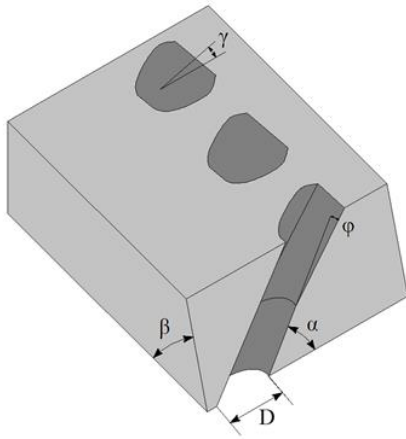

Figure 20 The geometry of compound shaped cooling hole [105]

Bell *et al.* [109] determined the adiabatic film cooling effectiveness downstream of cylindrical round simple angle holes, laterally diffused simple angle holes, laterally diffused compound angle holes, forward diffused simple angle holes and forward diffused compound angle holes. They investigated the effects of a range of blowing ratios from 0.4 to 1.4, momentum flux ratios from 0.17 to 3.5 and density ratios from 0.9 to 1.4 as well. In comparison with simple holes, higher span-wise averaged effectiveness was obtained within unlimited blowing ratios and momentum flux ratios downstream of laterally diffused compound angle.

Heneka *et al.* [110] designed a flat plate with cooling holes and plenum to determine the effect of different sharp edge diffused laidback fan-shaped cooling holes. They indicated that at elevated blowing ratios, the film cooling performance became better because at shallow inclination angles, the momentum of injected flow reduced and the coolant attached to the surface. Further away from injection holes, at $x/D > 20$, no significant effect was observed by compound angle variation. At fixed S_p/D ratio, the extended range of cooled surface was affected as the area ratio changed. However, a noticeable loss of film cooling effectiveness was seen when the area ratio went down below the specific magnitude.

Yipping *et al.* [111] simulated three rows of showerhead holes located on the blade leading edge. The test section included eighteen cooling holes with inclination angle of 30 degrees in the span-wise direction and 90 degrees along the flow direction. They considered three transverse cooling holes with angles of 0, 30 and 45 degrees and the shaping effectiveness of the additional angles of 30 and 45 degrees. As shown in Figure 21, for lower film cooling effectiveness and compound angle holes, increasing compound angle induces jet liftoff at higher blowing ratios and the film cooling performance dramatically increased in comparison with using lower transverse cooling holes angle. For shaped compound angle holes, there is a much greater increase in film cooling performance than with non-compound angle holes and baseline case.

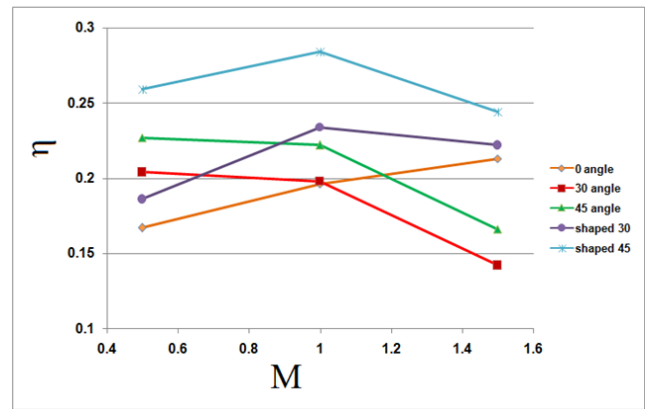

Figure 21 The effects of transverse angle variation on film cooling effectiveness [111]

Gao and Han [112] used PSP method to identify the effects of cooling holes angle and the configuration of these holes on film cooling within the blade leading edge surface. At a similar blowing ratio, the effects of seven rows of film cooling holes on film cooling performance was greater than those of three-row film cooling holes, which was due to the increase in the number of cooling hole rows. The deflection of the coolant from the radial angle holes by mainstream flow was higher than compound angle holes, hence covered an extended surface. Furthermore, the effectiveness achieved by using the three-row pattern was higher than that of compound angle hole due to the effect of radial angle holes. At elevated blowing ratios, the results attained from using seven rows of cooling holes were similar.

Dittmar *et al.* [113] studied the effects of different geometries of film cooling on heat transfer coefficient. The configuration included fan-shaped cooling holes, fan-shaped compound holes, double row of cylindrical holes and double row of discrete slots. The fan-shaped compound holes increased the cross flow cooling effectiveness at all blowing ratios. However, Hong-Wook Lee *et al.* [107] showed shaped holes have a suitable effect on cooling at moderate and high blowing ratios, especially at high blowing ratios. The results obtained from Bunker's [114] research showed that shaped film holes amenable to use with compound angles.

■ 8.0 COMPOUND TRENCHED SHAPED COOLING HOLES

As it is clear from its name, compound trenched shaped cooling hole is a combination of compound angle (stream-wise and span-wise direction), trenched hole and shaped case (Figure 22). Thus, the flow runs in both directions at angles of ϕ and γ degrees respectively from the horizontal surface, and it suddenly spreads at the end of the cooling hole. In addition, the shape of the hole varies from the inlet to the end.

Baheri *et al.* [104] applied CFD method to determine the changes of adiabatic film cooling effectiveness under four different cooling holes of cylindrical film (case 1), 15° forward diffused film (case 2), trenched cylindrical film (case 3) and trenched 15° forward-diffused film (case 4). The results indicated that trenching the cooling holes has a dramatic effect on adiabatic film cooling performance downstream the injection in the both directions of span-wise and stream-wise. Also, Figure 22 shows that the application of trenched compound angle injection shaped

hole provides the maximum film cooling. The ratio of the trenched hole length to diameter affects the film cooling and coolant injection.

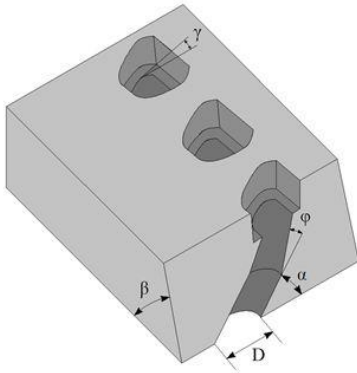

Figure 22 The schematic view of compound trenched shaped cooling hole [104]

9.0 SUMMARY

To have a better engine performance, the combustor's outlet temperature needs to be increased. However, hot flows develop non-uniformities and adverse conditions can damage the critical parts downstream the combustion chamber. The most well-known type of cooling preservation is film-cooling. However, the performance of traditional cooling holes is not good at higher blowing ratios. So far, many researchers have concentrated to design new shapes of cooling holes to modify the film cooling performance. Generally, the findings of these studies indicate that designing more rows of film cooling holes is more effective for film cooling performance. Also, when the distance between two adjacent holes is small, a better jet orifice cooling is achieved. Trenching cooling holes allows the injected coolant to spread before exiting the cooling holes. The studies considered the effects of width and depth of cooling holes for both row trench and individual trench. However, the results show that row trench is more effective than the other types. According to the findings, the narrow trench has better effect on film cooling performance. The best cooling performance is obtained at trench depth of 0.75. With shaped holes, the coolant attached to the surface and the film cooling performance which is achieved is thus higher than with cylindrical ones. In compound angle holes, the increase of jet's free stream interaction leads to the enhancement of normalized heat transfer coefficient, especially at the orientation angle of above 60 degrees.

From previous studies, it is found that the effects of trenched depth and width changes, and eventually the individual and row trenched cooling holes on flow behavior around turbine blades are considered. However, there are several unanswered questions. How trenched cooling holes modify the film cooling performance at the combustor end wall surface compared to cylindrical case? What is the optimum depth and width for the trenched cooling holes located at the combustor end wall surface? What are the effects of using row trenched cooling holes with different alignment angles on film cooling performance at the combustor exit? How does flow behaves under different blowing ratios for trenched cases at the end of combustor?

Acknowledgement

The authors would like to thank Universiti Teknologi Malaysia and the Ministry of Education of Malaysia for supporting this research activity. This research was financially supported by the Research University Grant 06H23.

References

- [1] S.S. Vakil, K.A. Thole. 2005. *Journal of Engineering for Gas Turbines and Power*. 127: 257
- [2] J. Polezhaev. 1997. *Energy Conversion and Management*. 38: 1123.
- [3] A. Kassab, E. Divo, J. Heidmann, E. Steinhorsson, F. Rodriguez. 2003. *International Journal of Numerical Methods for Heat & Fluid Flow*. 13: 581.
- [4] B. Leger, P. Miron, J.M. Emidio. 2003. *International Journal of Heat and Mass Transfer*. 46: 1215.
- [5] G. Xie, B. Sunden. 2010. *Journal of Heat Transfer Engineering*. 31: 527.
- [6] C. Shuping. 2008. *Film cooling enhancement with surface restructure*. Doctor Philosophy. University of Pittsburgh. Pennsylvania.
- [7] G. Scheepers, R.M. Morris. 2009. *Journal of Turbomachinery*. 131: 044501.
- [8] M.K. Harrington, M.A. McWaters, D. G. Bogard, C.A. Lemmon, K.A. Thole. 2001. *Journal of Turbomachinery*. 123: 798.
- [9] I. Koc, C. Parmaksizoglu, M. Cakan. 2006. *Energy Conversion and Management*. 47: 1231.
- [10] L. Yuzhen, S. Bo, L. Bin, L. Gaoen. 2006. *Journal of Heat Transfer*. 128: 192.
- [11] W. Ai, T.H. Fletcher. 2012. *Journal of Turbomachinery*. 134: 041020.
- [12] L. Cun-liang, Z. Hui-ren, Z. Zong-wei, X. Du-chun. 2012. *International Journal of Heat and Mass Transfer*. 55: 6832.
- [13] Y.L. Jun, K. Shun. 2013. *International Journal of Heat and Mass Transfer*. 56: 158.
- [14] K. Abdullah, K.I. Funazaki. 2012. *AEROTECH IV Conference*, Kuala Lumpur. Malaysia.
- [15] S. Sarkar, T. K. Bose. 1995. *Sadhana*. 20: 915.
- [16] H. Nasir, S. V. Ekkad, S. Acharya. 2001. *Experimental Thermal and Fluid Science*. 25: 23.
- [17] S. R. Shine, S. Sunil Kumar, B. N. Suresh. 2013. *Energy Conversion and Management*. 68: 54.
- [18] C.A. Hale, M.W. Plesniak, S. Ramadhyani. 2000. *Journal of Turbomachinery*. 122: 553.
- [19] M.B. Jovanovic, H.C. De Lange, A.A. Van Steenhoven. 2006. *International Journal of Heat and Fluid Flow*. 27: 42.
- [20] M.B. Jovanovic, H.C. De Lange, A.A. Van Steenhoven. 2008. *International Journal of Heat and Fluid Flow*. 29: 377.
- [21] S. D. Peterson, M.W. Plesniak. 2002. *Experiments in Fluids*. 33: 889.
- [22] M.W. Plesniak. 2006. *Journal of Applied Mechanics*. 73: 474.
- [23] K. Nakabe, K. Inaoka, T. AI, K. Suzuki. 1997. *Energy Conversion and Management*. 38: 1145.
- [24] C.A. Hale, M.W. Plesniak, S. Ramadhyani. 2000. *Journal of Turbomachinery*. 122: 553.
- [25] S.W. Burd, T.W. Simon. 1999. *Journal of Turbomachinery*. 121: 243.
- [26] A. Azzi, B.A. Jubran. 2003. *International Journal of Heat and Mass Transfer*. 39: 345.
- [27] S. Bernsdorf, M. Rose, R.S. Abhari. 2006. *Journal of Turbomachinery*. 128: 141.
- [28] X. Yong-gang, W. Qiang. 2013. *Applied Mechanics and Materials*. 278: 267.
- [29] G.W. Jumper, W. C. Elrod, R. B. Rivir. 1991. *Journal of Turbomachinery*. 113: 479.
- [30] C. Saumweber, A. Schulz. 2012. *Journal of Turbomachinery*. 134: 061008.
- [31] H.A. Mohammed, Y.K. Salman. 2007. *Energy Conversion and Management*. 48: 2233.
- [32] F. Nemdili, A. Azzi, B.A. Jubran. 2011. *International Journal of Heat and Fluid Flow*. 21: 46.
- [33] S. Li, P. Tao, L. Li-xian, G. Ting-ting, Y. Bin. 2007. *International Conference on Power Engineering*. Hangzhou, China.
- [34] D.J. Mee, P.T. Ireland, S. Bather. 1999. *Experiments in Fluids*. 27: 273.
- [35] H. Nasir, S. Acharya, S. Ekkad. 2003. *International Journal of Heat and Fluid Flow*. 24: 657.
- [36] D.A. Rowbury, M.L. G. Oldfield, G. D. Lock. 2001. *Journal of Turbomachinery*. 123: 593.

- [37] D.A. Rowbury, M.L.G. Oldfield, G. D. Lock. 2001. *Journal of Turbomachinery*. 123: 258.
- [38] L. Tarchi, B. Facchini, F. Maiuolo, D. Coutandin. 2012. *Journal of Engineering for Gas Turbines and Power*. 134: 041505.
- [39] D.W. Milanese, D.R. Kirk, K.J. Fidkowski, I.A. Waitz. 2006. *Journal of Engineering for Gas Turbines and Power*. 128: 318.
- [40] M.D. Barringer, O.T. Richard, J.P. Walter, S.M. Stitzel, K.A.Thole. 2002. *Journal of Turbomachinery*. 124: 508.
- [41] L. Li, T. Liu, X. F. Peng. 2005. *Applied Thermal Engineering*. 25: 3013.
- [42] J.J. Scrittore. 2008. *Experimental Study of the Effect Of Dilution Jets On Film Cooling Flow In A Gas Turbine Combustor*. PhD theses. Virginia Polytechnic Institute and State University.
- [43] L. Cun-liang, Z. Hui-ren, B. Jiang-tao, X. Du-chun. 2010. *International Journal of Heat and Mass Transfer*. 53: 5232.
- [44] L. Cun-liang, Z. Hui-ren, B. Jiang-tao, X. Du-chun. 2011. *Journal of Turbomachinery*. 133: 011020.
- [45] C.L. Liu, H. R. Zhu, J. T. Bai. 2012. *Journal of Turbomachinery*. 134: 011021.
- [46] R.S. Bunker. 2011. *Journal of Turbomachinery*. 133: 011022.
- [47] J.E. Sargison, M.L.G. Oldfield, S. M. Guo, G.D. Lock, A.J. Rawlinson. 2005. *Experiments in Fluids*. 38: 304.
- [48] G. Barigozzi, G. Franchini, A. Perdichizzi. 2007. *Journal of Turbomachinery*. 129: 212.
- [49] L. Xiangyun, T. Zhi, D. Shuiting, X. Guoqiang. 2013. *Applied Thermal Engineering*. 50: 1186.
- [50] E.B.B. Joshua, F. T. Davidson, D.G. Bogard, D.R. Johns. 2011. *Journal of Turbomachinery*. 133: 031020–1.
- [51] A.A. Thrift, K.A. Thole, S. Hada. 2012. *Journal of Turbomachinery*. 134: 061019.
- [52] S.P. Lynch, K.A. Thole. 2008. *Journal of Turbomachinery*. 130: 041019.
- [53] E. Kianpour, N.A.C. Sidik, M. Agha Seyyed Mirza Bozorg. 2012. *AEROTECH IV*. Kuala Lumpur. Malaysia.
- [54] E. Kianpour, N.A.C. Sidik, M. Agha Seyyed Mirza Bozorg. 2012. *Jurnal Teknologi*. 58: 5.
- [55] N. Sundaram, K. A. Thole. 2009. *Journal of Turbomachinery*. 131: 041007.
- [56] N. Sundaram, K.A. Thole. 2008. *Journal of Turbomachinery*. 130: 041013.
- [57] S. A. Lawson, K.A.Thole. 2012. *Journal of Turbomachinery*. 134: 051040.
- [58] S.K. Wayne, D.G. Bogard. 2007. *Journal of Turbomachinery*. 129: 294.
- [59] L. Yiping, A.Dhungal, S.V. Ekkad, R.S. Bunker. 2009. *Journal of Turbomachinery*. 131: 011003.
- [60] G. Barigozzi, G. Franchini, A. Perdichizzi, S. Ravelli. 2012. *Journal of Turbomachinery*. 134: 041009.
- [61] R.P. Somawardhana, D.G. Bogard. *Journal of Turbomachinery*. 131: 011010.
- [62] K.L. Harrison, J.R. Dorrington, J.E. Dees, D.G. Bogard, R.S. Bunker. 2009. *Journal of Turbomachinery*. 131: 011012.
- [63] L. Yiping, S.V. Ekkad. 2006. *9th AIAA/ASME Joint Thermophysics and Heat Transfer Conference*. The United States of America, California.
- [64] W. Ai, R.G. Laycock, D.S. Rappleye, T.H. Fletcher, J.P. Bons. 2011. *Energy & Fuels*. 25: 1066.
- [65] F.H. Asghar, M.J. Hyder. 2011. *Energy Conversion and Management*. 52: 329.
- [66] G. Barigozzi, G. Benzone, G. Franchini, A. Perdichizzi. 2006. *Journal of Turbomachinery*. 128: 43.
- [67] K. D. Lee, K. Y. Kim. 2010. *International Journal of Heat and Mass Transfer*. 53: 2996.
- [68] K.D. Lee, K.Y. Kim. 2011. *International Journal of Heat and Fluid Flow*. 32: 226.
- [69] K.D. Lee, K.Y. Kim. 2012. *Journal of Heat Transfer*. 134: 101702.
- [70] C. Saumweber, A. Schulz. 2004. *Journal of Turbomachinery*. 126: 237.
- [71] X.Z. Zhang, I. Hassan. 2006. *International Journal of Heat and Fluid Flow*. 16: 848.
- [72] Z. Gao, D. Narzary, J.C. Han. 2009. *Journal of Turbomachinery*. 131: 041004.
- [73] W. Colban, K.A. Thole, M. Haendler. 2008. *Journal of Turbomachinery*. 130: 031007.
- [74] C. Saumweber, A. Schulz, S. Wittig. 2003. *Journal of Turbomachinery*. 125: 65.
- [75] C. Saumweber, A. Schulz. 2012. *Journal of Turbomachinery*. 134: 061007.
- [76] G. Barigozzi, G. Franchini, A. Perdichizzi, S. Ravelli. 2010. *International Journal of Heat and Fluid Flow*. 31: 576.
- [77] R.J. Fawcett, A.P.S.Wheeler, L. He, R. Taylor. *Journal of Turbomachinery*. 134: 021015.
- [78] W. Peng, P.X. Jiang. 2012. *Experimental Heat Transfer*. 25: 282.
- [79] S. Bayraktar, T. Yilmaz. 2011. *Energy Conversion and Management*. 52: 1914.
- [80] L.Zhang, T. Guo, S. Li, J. Liu. 2007. *International Conference on Power Engineering*, Hangzhou, China.
- [81] W. Colban, K.A. Thole, M. Haendler. 2007. *Journal of Turbomachinery*. 129: 23.
- [82] W. Colban, A. Gratton, K.A. Thole, M. Haendler. 2006. *Journal of Turbomachinery*. 128: 53.
- [83] W. Colban, K. Thole. 2007. *International Journal of Heat and Fluid Flow*. 28: 341.
- [84] W.L. Sang, R.B. Jong, S.L. Dae. 1998. *KSME International Journal*. 12: 301.
- [85] M. Gritsch, A. Schulz, S. Wittig. 2001. *Journal of Turbomachinery*. 123: 781.
- [86] V. Aga, R.S. Abhari. 2011. *Journal of Turbomachinery*. 133: 031029–1.
- [87] B.A.Jubran, A.K. Al-Hamadi, G. Theodoridis. 1997. *Journal of Heat and Mass Transfer*. 33: 93.
- [88] B. Han, D.K. Sohn, J.S. Lee. 2002. *KSME International Journal*. 16: 1137.
- [89] I.C. Lee, Y.C. Chang, P.P. Ding, P.H. Chen. 2005. *Journal of the Chinese Institute of Engineers*. 28: 827.
- [90] V. Aga, M. Rose, R. S. Abhari. 2008. *Journal of Turbomachinery*. 130: 031005–1.
- [91] H. L. Jung, K. C. Young. 1998. *KSME International Journal*. 12: 963.
- [92] S. Stitzel, K.A. Thole. 2004. *Journal of Turbomachinery*. 126: 122.
- [93] B.A. Jubran, B.Y. Maiteh. 1999. *Heat and Mass Transfer*. 34: 495.
- [94] B.Y. Maiteh, B.A. Jubran. 2004. *Energy Conversion and Management*. 45: 1457.
- [95] A. Azzi, B.A. Jubran. 2004. *Heat and Mass Transfer*. 40: 501.
- [96] L. Zhang, G. Wen. 2011. *The Tenth International Conference on Electronic Measurement & Instruments*. China.
- [97] Y.L. Lin, T.I.P. Shih. 2001. *Journal of Heat Transfer*. 123: 645.
- [98] L.M. Wright, S.T. McClain, M.D. Clemenson. 2011. *Journal of Turbomachinery*. 133: 041023.
- [99] C. Han, J. Ren, H. d. Jiang. 2012. *International Journal of Heat and Mass Transfer*. 55: 4232.
- [100] S.R. Shine, S.S. Kumar, B.N. Suresh. 2011. *Heat Mass Transfer*. 48: 849.
- [101] A.K. Al-Hamadi, B.A. Jubran, G. Theodoridis. 1998. *Energy Conversion and Management*. 39: 1449.
- [102] S. Baheri Islami, S.P. Alavi Tabrizi, B.A. Jubran, E. Esmaeilzadeh. 2010. *Heat Transfer Engineering*. 31: 889.
- [103] S. Baheri Islami, B.A. Jubran. 2011. *Heat Mass Transfer*. 48: 831.
- [104] S. Baheri Islami, S.P. Alavi Tabrizi, B.A. Jubran. 2008. *Numerical Heat Transfer*. 53: 308.
- [105] Z. Gao, D.P.Narzary, J.C. Han. 2008. *International Journal of Heat and Mass Transfer*. 51: 2139–2152.
- [106] Z. Gao, D.P. Narzary, H. Je-Chin. 2009. *Journal of Turbomachinery*. 131: 011019.
- [107] L. Hong-Wook, P. Jung-Joon, S. L. Joon. 2002. *International Journal of Heat and Mass Transfer*. 45: 145.
- [108] S. Mhetras, J.C. Han, R. Rudolph. 2012. *Journal of Turbomachinery*. 134: 011004.
- [109] C.M. Bell, H. Hamakawa, P.M. Ligrani. 2000. *Journal of Heat Transfer*. 122: 224.
- [110] C. Heneka, A. Schulz, H.J. Bauer, A. Heselhaus, M.E. Crawford. 2012. *Journal of Turbomachinery*. 134: 041015.
- [111] L.Yiping, D. Allison, S.V. Ekkad. 2007. *International Journal of Heat and Fluid Flow*. 28: 922.
- [112] Z. Gao, J.C. Han. 2009. *Journal of Heat Transfer*. 131: 061701.
- [113] J. Dittmar, A. Schulz, S. Wittig. 2007. *Journal of Turbomachinery*. 125: 57.
- [114] R.S. Bunker. 2005. *Journal of Heat Transfer*. 127: 441