

SLIDING MODE CONTROL OF A HYDRAULICALLY ACTUATED ACTIVE SUSPENSION

YAHAYA MD. SAM^{1*} & JOHARI HALIM SHAH OSMAN²

Abstract. The objective of this paper is to present a new mathematical model and robust control technique for modeling and control of an active suspension system with hydraulic dynamics for a quarter car model. The purpose of a car suspension system is to improve the riding quality while maintaining good handling characteristics subject to different road profiles. The objective of designing a controller for a car suspension system is to improve the riding quality without compromising the handling characteristic by directly controlling the suspension forces to suit the road and driving conditions. In this paper, a new mathematical model is presented which will give a much more complete mathematical representation of a hydraulically actuated suspension system for the quarter car model. However, the mathematical model obtained suffers from mismatched condition. In order to achieve the desired ride comfort and road handling and to solve the mismatched condition, a proportional-integral sliding mode control technique is presented to deal with the system and uncertainties. The effect of boundary layer thickness selection in the proposed controller is also presented. Extensive simulations are performed and the results showed that the proposed controller performed well in improving the ride comfort and road handling for the quarter car model using the hydraulically actuated suspension system.

Keyword: Active suspension, automotive control, sliding mode control

Abstrak. Kertas penyelidikan ini bertujuan untuk memperkenalkan model matematik dan teknik kawalan yang baru dalam pemodelan dan kawalan sistem gantungan aktif berdinamik hidraulik untuk model kereta suku. Sistem gantungan kereta berfungsi untuk memperbaiki kualiti pemanduan di samping mengekalkan ciri-ciri pengendalian yang baik dalam apa jua bentuk permukaan jalan. Reka bentuk sistem kawalan dalam sistem gantungan kereta berperanan untuk mengawal secara terus daya gantungan agar bersesuaian dengan keadaan permukaan jalan dan pemanduan. Dalam kertas penyelidikan ini, model matematik sistem gantungan tergerak hidraulik untuk model kereta suku akan diuraikan dengan lebih terperinci. Walau bagaimanapun, pemodelan matematik sistem gantungan ini menghadapi masalah keadaan tak terpadan. Oleh itu, suatu kaedah baru yang dikenali sebagai kawalan ragam gelincir berkadar-kamiran dicadangkan untuk mengatasi masalah keadaan tak terpadan di samping mencapai tahap selesa pemanduan dan kendalian jalan yang dikehendaki. Kesan ke atas ketebalan lapisan sempadan terhadap pengawal yang dicadangkan juga dibincangkan. Penyelidikan komputer telah dijalankan dan keputusan yang diperolehi menunjukkan pengawal yang dicadangkan berupaya memperbaiki tahap selesa pemanduan dan kendalian jalan untuk model kereta suku berkenaan.

Kata kunci: Gantungan aktif, kawalan automotif, kawalan ragam gelincir

^{1&2} Faculty of Electrical Engineering, Universiti Teknologi Malaysia, 81310 Skudai, Johor, Malaysia
^{*} Corresponding author: Email: yahaya@fke.utm.my

1.0 INTRODUCTION

The development of an active suspension system for a vehicle is of great interest to both academic and industry. The study of active suspension system has been performed using various suspension models. Generally, vehicle suspension models are divided into three types: quarter car, half car and full car models. In the quarter car model, the model takes into account the interaction between the quarter car body and the single wheel. The motion of the quarter car model is only in the vertical direction. For the half car model, the interactions are between the car body and the wheels and also between both ends of the car body. The first interaction in the half car model caused the vertical motion and the second interaction produced an angular motion. In the full car model, the interactions are between the car body and the four wheels that generate the vertical motion, between the car body and the left and right wheels that generate an angular motion called rolling, and between the car body and the front and rear wheels that produce the pitch motion.

Modeling of the active suspension systems in the early days considered the input to the active suspension to be a linear force. Active suspension with linear force input is presented in [1, 2]. Recently, due to the development of new control theories, the force input to the active suspension systems has been replaced by an input to control the actuator. Therefore, the dynamics of the active suspension systems now consists of the dynamics of suspension system plus the dynamics of the actuator systems. Hydraulic actuators are widely used in the active suspension system as presented in [3 - 6].

Various control laws such as adaptive control [7], backstepping method [4], optimal state-feedback [1], fuzzy control [6], and sliding mode control [8] have been proposed in the past years to control the active suspension system. The sliding mode control has a relatively simpler structure and it guarantees system stability.

In this paper, we will consider a new method in integrating the hydraulic actuator dynamics with the active suspension system and propose a control scheme that can further improve the ride comfort and road handling of the active suspension system. The proposed control scheme differs from the previous sliding mode control techniques in the sense that the sliding surface is based on the proportional-integral sliding mode control instead of the conventional sliding surface.

2.0 DYNAMIC MODEL OF ACTIVE SUSPENSION

In the past, most active suspension designs were developed based on the quarter-car model as shown in Figure 1, where m_b and m_w are the mass for the car body and car wheel, respectively, k_b and k_w are the stiffness of the car body spring and car tyre, respectively, c_b is the damping constant for the damper, x_b and x_w are the vertical displacement of the car body and the car wheel, respectively, f_a is the control force that is generated by the actuating ram in the hydraulic cylinder as presented in [8],

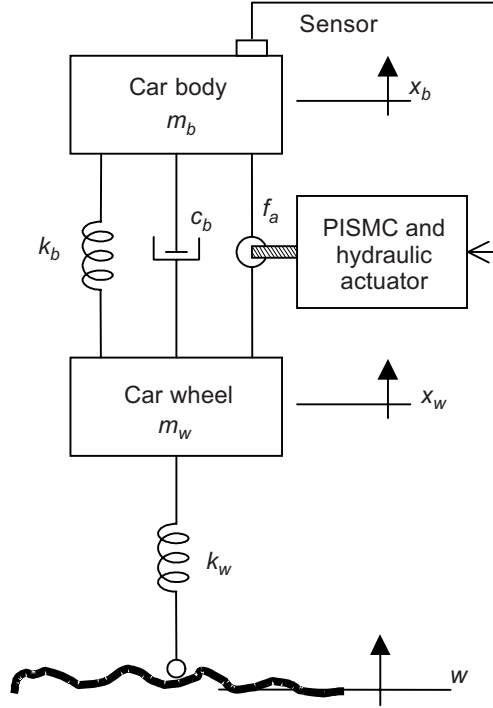

Figure 1 Active suspension with hydraulic actuator for a quarter car model

and w is an irregular excitation from the road surface. In the model, it is assumed that all the suspension components are linear.

From Figure 1, the dynamic equations for a quarter car model can be obtained as follows:

$$m_b \ddot{x}_b + c_b (\dot{x}_b - \dot{x}_w) + k_b (x_b - x_w) - f_a = 0 \quad (1)$$

$$m_w \ddot{x}_w + c_b (\dot{x}_w - \dot{x}_b) + k_b (x_w - x_b) + k_w (x_w - w) + f_a = 0 \quad (2)$$

From [8], the hydraulic actuator's dynamics is given as follows:

$$\dot{f}_a = -\frac{1}{A_e} f_a - \frac{A_y}{A_e} (\dot{x}_b - \dot{x}_w) + \frac{1}{A_e} u \quad (3)$$

where A_e and A_y are the hydraulic actuator constants.

By augmenting the above equations, the following state-space equation can be easily obtained for the hydraulically actuated active suspension system for the quarter car model:

$$\begin{bmatrix} \ddot{x}_b \\ \ddot{x}_w \\ \dot{x}_b \\ \dot{x}_w \\ \dot{f}_a \end{bmatrix} = \begin{bmatrix} -\frac{c_b}{m_b} & \frac{c_b}{m_b} & -\frac{k_b}{m_b} & \frac{k_b}{m_b} & \frac{1}{m_b} \\ \frac{c_b}{m_w} & -\frac{c_b}{m_w} & \frac{k_b}{m_w} & -\frac{(k_b + k_w)}{m_w} & -\frac{1}{m_w} \\ 1 & 0 & 0 & 0 & 0 \\ 0 & 1 & 0 & 0 & 0 \\ -\frac{A_y}{A_e} & \frac{A_y}{A_e} & 0 & 0 & -\frac{1}{A_e} \end{bmatrix} \begin{bmatrix} \dot{x}_b \\ \dot{x}_w \\ x_b \\ x_w \\ f_a \end{bmatrix} + \begin{bmatrix} 0 \\ 0 \\ 0 \\ 0 \\ \frac{1}{A_e} \end{bmatrix} u(t) + \begin{bmatrix} 0 \\ \frac{k_w}{m_w} \\ 0 \\ 0 \\ 0 \end{bmatrix} w(t) \quad (4)$$

It can be seen from Equation (4) that the system suffer from mismatched condition where the input $u(t)$ is not in the range space of the disturbance input $w(t)$.

In general, Equation (4) can be written in a compact form as:

$$\dot{x}(t) = Ax(t) + Bu(t) + f(x, t) \quad (5)$$

where $x(t) \in \mathfrak{R}^n$ is the state vector, $u(t) \in \mathfrak{R}^m$ is the control input, and the continuous function $f(x, t)$ represents the uncertainties with the mismatched condition. The following assumptions are taken as standard:

Assumption i: There exists a known positive constant β such that $\|f(x, t)\| \leq \beta$, where $\|\bullet\|$ denotes the standard Euclidean norm.

Assumption ii: The pair (A, B) is controllable and the input matrix B has full rank.

3.0 THE CONTROLLER DESIGN

In this study, the PI sliding surface defined below is used:

$$\sigma(t) = Cx(t) - \int_0^t (CA + CBK) \times (\tau) d\tau \quad (6)$$

where $C \in \mathfrak{R}^{m \times n}$ and $K \in \mathfrak{R}^{m \times n}$ are constant matrices. The matrix K satisfies $\lambda_{\max}(A + BK) < 0$ and C is chosen so that CB is nonsingular. The integral term provides one more degree of freedom in the design than the conventional sliding surface [9]. This will provide more flexibility in determining the sliding surface and also reduce the steady-state error.

It is well known that if the system is able to enter the sliding mode, $\sigma(t) = 0$. Therefore, the equivalent control, $u_{eq}(t)$ can thus be obtained by letting $\dot{\sigma}(t) = 0$ [10] i.e.,

$$\dot{\sigma}(t) = C\dot{x}(t) - \{CA + CBK\}x(t) = 0 \quad (7)$$

If the matrix C is chosen such that CB is nonsingular, this yields:

$$u_{eq}(t) = Kx(t) - (CB)^{-1}Cf(x, t) \quad (8)$$

Substituting Equation (8) into system (5) gives the equivalent dynamic equation of the system in sliding mode as:

$$\dot{x}(t) = (A + BK)x(t) + \{I_n - B(CB)^{-1}C\}f(x, t) \quad (9)$$

Theorem 1: If $\|\tilde{F}(x, t)\| \leq \beta_1$ where $\beta_1 = \|I_n - B(CB)^{-1}C\|\beta$ and $\tilde{F}(x, t) = \{I_n - B(CB)^{-1}C\}f(x, t)$, the uncertain system in Equation (6) is boundedly stable on the sliding surface $\sigma(t) = 0$

Proof of Theorem 1: For simplicity, we let

$$\tilde{A} = (A + BK) \quad (10)$$

$$\tilde{F}(x, t) = \{I_n - B(CB)^{-1}C\}f(x, t) \quad (11)$$

and rewrite Equation (9) as

$$\dot{x}(t) = \tilde{A}x(t) + \tilde{F}(x, t) \quad (12)$$

Let the Lyapunov function candidate for the system is chosen as

$$V(t) = x^T(t)Px(t) \quad (13)$$

Taking the derivative of $V(t)$ and substituting Equation (9) into it, gives

$$\begin{aligned} \dot{V}(t) &= x^T(t)[\tilde{A}^T P + P\tilde{A}]x(t) + \tilde{F}^T(x, t)Px(t) + x^T(t)P\tilde{F}(x, t) \\ &= -x^T(t)Qx(t) + \tilde{F}^T(x, t)Px(t) + x^T(t)P\tilde{F}^T(x, t) \end{aligned} \quad (14)$$

where P is the solution of $\tilde{A}^T P + P\tilde{A} = -Q$ for a given positive definite symmetric matrix Q . It can be shown that Equation (14) can be reduced to:

$$\dot{V}(T) = -\lambda_{\min}(Q)\|x(t)\|^2 + 2\beta_1\|P\|\|x(t)\| \quad (15)$$

Since $\lambda_{\min}(Q) > 0$, consequently $\dot{V}(t) < 0$ for all t and $x \in B^c(\eta)$, where $B^c(\eta)$ is the complement of the closed ball $B(\eta)$, centered at $x = 0$ with radius $\eta = 2\beta_1 \|P\| / \lambda_{\min}(Q)$. Hence, the system (5) is uniformly ultimately bounded.

Remark 2: For the system with uncertainties satisfying the matching condition, i.e., $\text{rank}[B|f(x, t)] = \text{rank}[B]$, then Equation (9) can be reduced to $\dot{x}(t) = (A + BK) \times(t)$ [11]. Thus asymptotic stability of the system during sliding mode is assured.

The control scheme that drives the state trajectories of the system in Equation (5) onto the sliding surface $\sigma(t) = 0$ and the system remains in it thereafter is now being designed. For the uncertain system in Equation (5) satisfying assumptions (i) and (ii), the following control law is proposed:

$$u(t) = Kx(t) - (CB)^{-1} Cf(x, t) - (CB)^{-1} \rho \frac{\sigma(t)}{|\sigma(t)| + \delta} \quad (16)$$

where K is the vector of closed loop gains, ρ is the sliding gain, and δ is the boundary layer thickness which is selected to reduce the chattering problem.

Very small value of the boundary layer thickness may cause a very large control input, consequently, the control input does not have the ability to reject the chattering [12]. On the contrary, if the boundary layer thickness is selected as a large number, chattering can be reduced, however, the system dynamics may become unstable because of a wide boundary layer. Therefore, the boundary layer should be selected very carefully based on the system characteristics.

The state trajectories that are driven by the above controller will slide on the designed sliding surface if the reaching condition $\sigma(t)\dot{\sigma}(t) < 0$ is satisfied. To evaluate the reaching condition, we express,

$$\sigma(t)\dot{\sigma}(t) = \sigma(t)[CBu(t) + Cf(x, t) - CBKx(t)] \quad (17)$$

Substituting Equation (16) into Equation (17), gives:

$$\sigma(t)\dot{\sigma}(t) = \sigma(t) \left[-\rho \frac{\sigma(t)}{|\sigma(t)| + \delta} \right] \quad (18)$$

Equation (18) shows that the hitting condition of the sliding surface (6) is satisfied if $\rho > 0$.

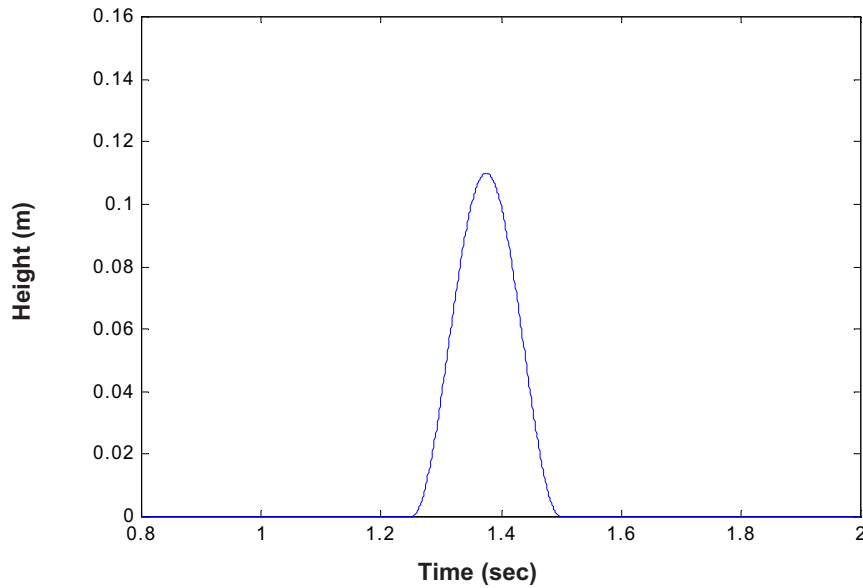

Figure 2 The road disturbance is represented by a bump

4.0 SIMULATIONS AND DISCUSSION

The mathematical model of the system as defined in Equation (5) and the proposed PI sliding mode controller (PISMC) in Equation (16) were simulated on computer. Effect of varying the boundary layer thickness in Equation (16) was also simulated. Extensive simulations have been performed in [14]. Numerical values for the model parameters are taken from [8], and tabulated in Table 1.

Table 1 Active suspension parameters

Parameter	Symbol	Value	Units
Mass of car body	m_b	290	kg
Mass of car wheel	m_w	59	kg
Stiffness of the car body spring	k_b	16812	N/m
Stiffness of car tyre	k_w	190000	N/m
Damping constant	c_b	1000	Ns/m

The following road profile $w(t)$ is used in the simulation:

$$w(t) = \begin{cases} a(1 - \cos 8\pi t), & 1.25 \text{ sec} \leq t \leq 1.5 \text{ sec} \\ 0, & \text{otherwise} \end{cases}$$

a denote the bump amplitude where $a = 11$ cm is used.

The road profile $w(t)$ is shown in Figure 2. This type of road profile has been used by [4, 13] in their studies. For the PISMC, we utilize the pole placement method to determine the value of K such that $\lambda(A + BK) = \{-50, -100, -110, -120, -500\}$. This yields $K = [-1.65 \times 10^8, -1.88 \times 10^7, -3.34 \times 10^9, 1.08 \times 10^9, -970.35]$. In this simulation, the following values are selected for the respective controller parameters: $C = [3 \ 2 \ 5 \ 10 \ 30]$, $\rho = 10$, $\delta = 1 \times 10^{-2}$, $A_y = 15$, and $A_e = 1.13$. Effects of the boundary layer thickness are shown by using $\delta = 1 \times 10^{-2}$ and $\delta = 1 \times 10^4$.

In order to fulfill the objective of designing the active suspension system, i.e. to increase the ride comfort and road handling, there are two parameters to be observed in the simulations. The two parameters are the car body acceleration and wheel deflection. Figure 3(a) shows the suspension travel under the active suspension and

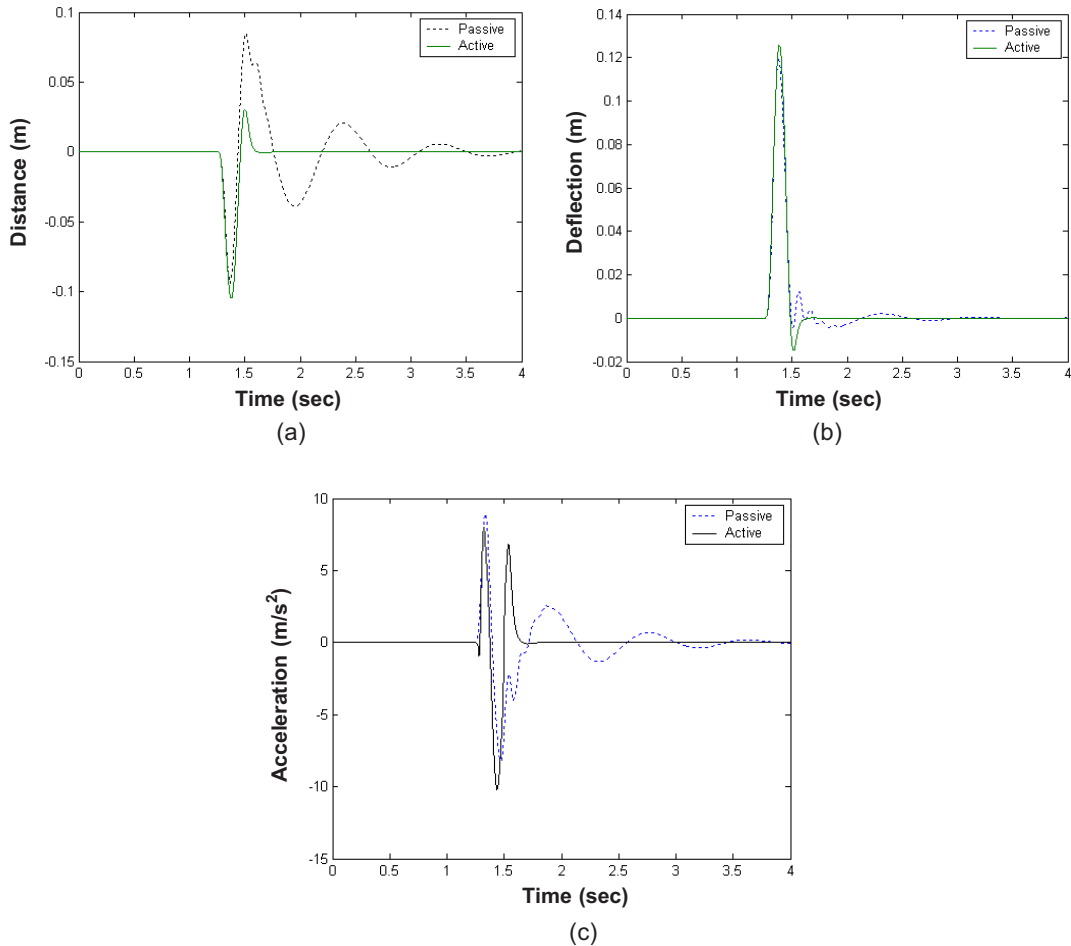

Figure 3 Performance of passive and active suspension: (a) Suspension travel, (b) Wheel deflection, (c) Body acceleration

passive suspension systems for comparison purposes. The result shows that the oscillation of the suspension travel is very much reduced as compared to the passive suspension system.

Moreover, the wheel deflection as shown in Figure 3(b) is also smaller using the proposed controller. Figure 3(c) illustrates clearly how the PISMIC can effectively absorb the vehicle vibration in comparison to the passive system. The body acceleration using the PISMIC system is reduced significantly, which guarantees better ride comfort. Figures 4(a), 5(a), and 6(a) show chattering caused by the small value of boundary layer thickness in the suspension travel, wheel deflection and body

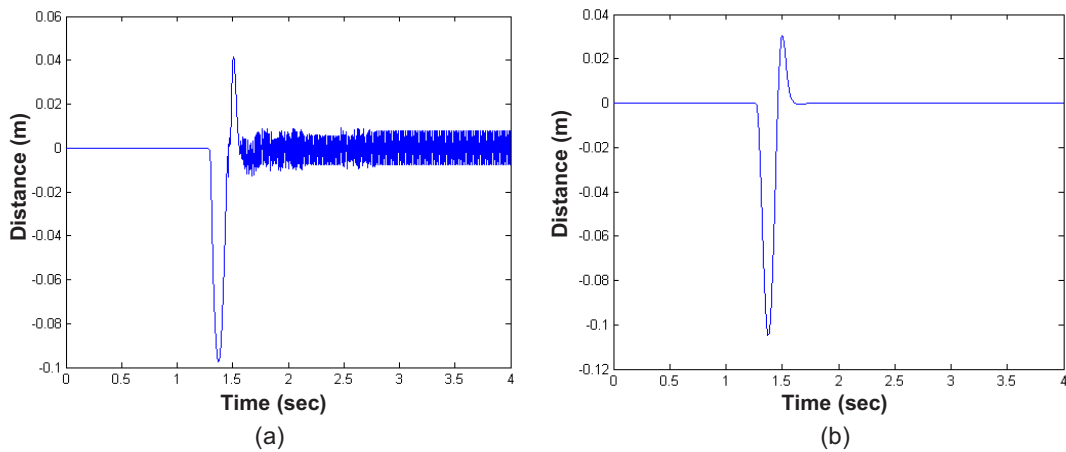

Figure 4 Performance of suspension travel with: (a) Chattering ($\delta = 1 \times 10^{-2}$), (b) No chattering ($\delta = 1 \times 10^4$)

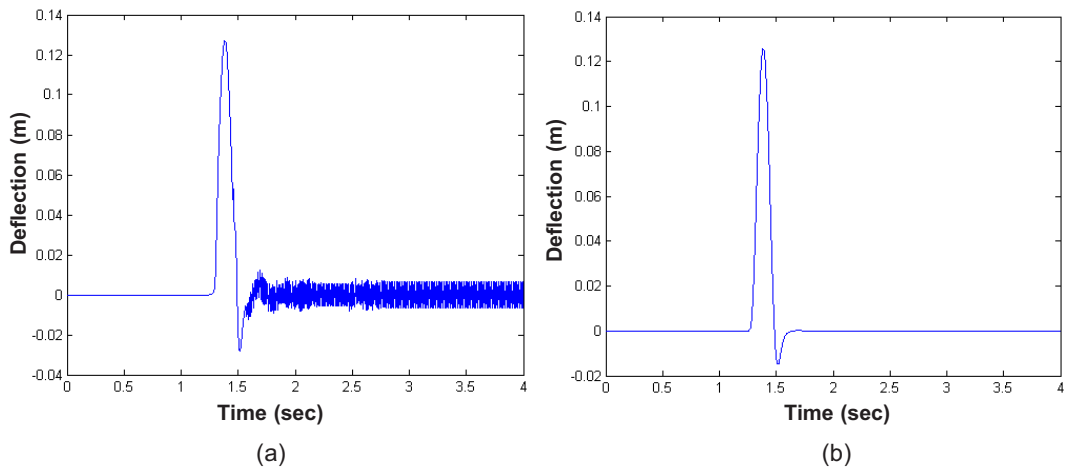

Figure 5 Performance of wheel deflection with: (a) Chattering ($\delta = 1 \times 10^{-2}$), (b) No chattering ($\delta = 1 \times 10^4$)

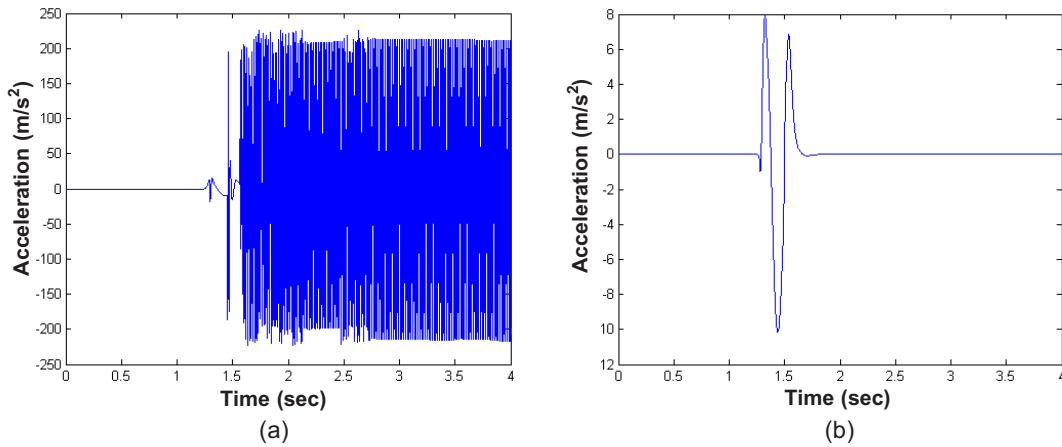

Figure 6 Performance of body acceleration with: (a) Chattering ($\delta = 1 \times 10^{-2}$), (b) No chattering ($\delta = 1 \times 10^4$)

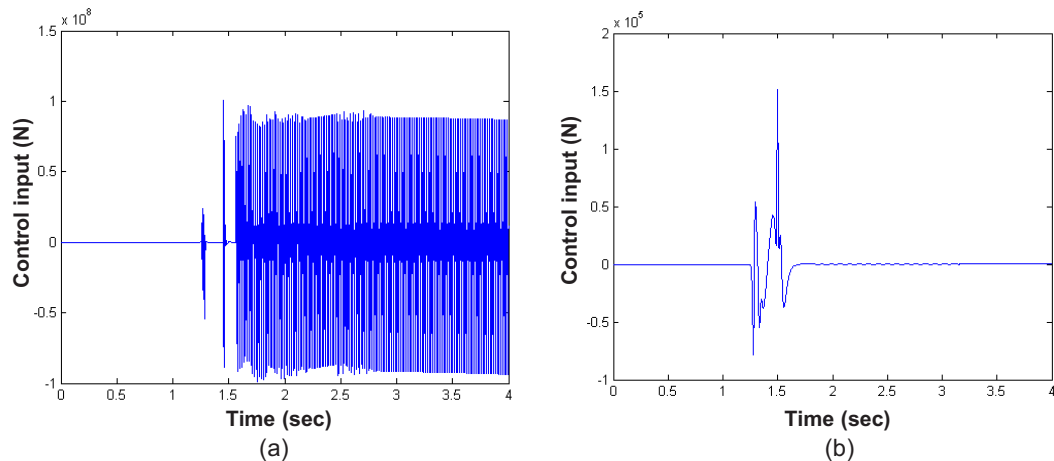

Figure 7 Control input with: (a) Chattering ($\delta = 1 \times 10^{-2}$), (b) No chattering ($\delta = 1 \times 10^4$)

acceleration, respectively. When the boundary layer thickness was large, the chattering is significantly reduced as shown in Figures 4(b), 5(b), and 6(b). Figures 7(a) and (b) show that a small value of boundary layer thickness has generated a very large control input compared to a large value of boundary layer thickness. Therefore, a large value of boundary layer thickness can eliminate chattering and hence helps eliminate the unnecessary vibration in the system. Thus, it is proven that the active suspension system with the PISMIC improves the ride comfort while retaining the road handling characteristics, as compared to the passive suspension system.

5.0 CONCLUSION

This paper presents a methodology to design a controller for an active suspension system integrated with hydraulic dynamics that is based on variable structure control theory, which is capable of satisfying all the pre-assigned design requirements within the actuators limitation. A detailed study of the proportional integral sliding mode control algorithm is presented. The boundary layer thickness is varied to observe the chattering effects in the nonlinear part of the proposed controller. The performance characteristics of the active suspension system is evaluated and then compared to the passive suspension system through computer simulation. The result shows that the use of the proposed proportional integral sliding mode control technique proved to be effective in controlling vehicle vibrations and achieve better performance than the passive suspension system. Moreover, small value of boundary layer thickness is capable to eliminate chattering in the proportional integral sliding mode controller.

ACKNOWLEDGEMENTS

The authors wish to express sincere gratitude to Professor T. Yoshimura from Tokushima University for his contributions in this research.

REFERENCES

- [1] Esmailzadeh, E., and H. D. Taghirad. 1996. Active Vehicle Suspensions with Optimal State-feedback Control. *Journal of Mechanical Science*. 200(4): 1-18.
- [2] Huang, S. J., and H. C. Chao. 2000. Fuzzy Logic Controller for Active Suspension System. *Proc. Instn. Mech. Engrs*. 214(D): 1-12.
- [3] Alleyne, A., and J. K. Hedrick. 1995. Nonlinear Adaptive Control of Active Suspensions. *IEEE Trans. on Control System Technology*. 3: 94-101.
- [4] Lin, J. S., and I. Kanellakopoulos. 1997. Nonlinear Design of Active Suspension. *IEEE Control System Magazine*. 17: 45-59.
- [5] Fialho, I., and G. J. Balas. 2002. Road Adaptive Active Suspension Design Using Linear Parameter-varying Gain-scheduling. *IEEE Transaction on Control Systems Technology*. 10(1): 43-54.
- [6] Yoshimura, Y., K. Nakaminami, M. Kurimoto, and J. Hino. 1999. Active Suspension of Passengers Cars Using Linear and Fuzzy-logic Controls. *Control Engineering Practice*. 7: 41-47.
- [7] Appleyard, M., and P. E. Wellstead. 1995. Active Suspension: Some Background. *Proc. Control Theory Applications*. 142: 123-128.
- [8] Yoshimura, T., A. Kume, M. Kurimoto, and J. Hino. 2001. Construction of an Active Suspension System of a Quarter Car Model Using the Concept of Sliding Mode Control. *Journal of Sound and Vibration*. 239: 187-199.
- [9] Cao, W. J., and J. X. Xu. 2001. Nonlinear Integral-type Sliding Surface for Both Matched and Unmatched Uncertain Systems. In *Proceedings of the American Control Conference*. 4369-4374.
- [10] Itkis, U. 1976. *Control System of Variable Structure*. New York: Wiley.
- [11] Edward, C., and S. Spurgeon. 1988. *Sliding Mode Control: Theory and Applications*. London: Taylor and Francis.

- [12] Lee, J. H., P. U. Allire, G. Tao, J. A. Decker, and X. Zhang. 2003. Experiment Study of Sliding Mode Control for a Benchmark Magnetic Bearing System and Artificial Heart Pump Suspension. *IEEE Trans. on Control System Technology*. 11: 128-138.
- [13] D'Amato, F. J., and D. E. Viasallo. 2000. Fuzzy Control for Active Suspensions. *Mechatronics*. 10: 897-920.
- [14] Yahaya, M. S. 2004. Modeling and Control of Active Suspension System Using Proportional Integral Sliding Mode Control. Ph. D. Thesis. UTM.