

## DETERMINING ALTERNATIVES FOR METAL FORMING LUBRICANTS: A STUDY USING PLANE STRAIN COLD EXTRUSION PROCESS OF JIS-A1100 PURE ALUMINUM BILLET

### Article history

Received  
16 January 2015  
Received in revised form  
24 March 2015  
Accepted  
15 March 2015

M. A. Nurul\*, S. Syahrullail, M. N. Musa

\*Corresponding author  
m.a.nurulaini@gmail.com

Faculty of Mechanical Engineering, Universiti Teknologi Malaysia,  
81310 UTM Johor Bahru, Johor, Malaysia

### Graphical abstract

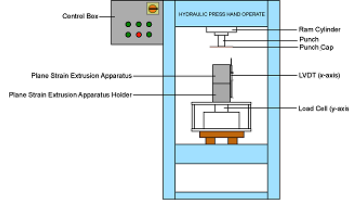

### Abstract

Lubrication is very important in metal forming processes to control wear and friction at the interface between interacting surfaces. Non-renewable resources, such as plain mineral oils are widely used due to its ability to act as a supplier to wearing contacts; it may function as a film material or even sustain chemical transformations to become a film material. Since non-renewable resources can only last for more than a decade, renewable resources have been studied in order to find alternative lubricants that can present similar results in terms of extrusion load and product quality. Two renewable lubricants were analyzed (RBD palm olein and jatropa) together with an additive free paraffinic mineral oil, VG32, which acted as a reference lubricant. The experiment used a cold work plane strain extrusion apparatus that consists of a pair of taper die and a symmetrical work piece (billet). The billet material was made of annealed pure aluminum JIS-A1100 with radius of 5 mm in the deformation area. It was found that higher viscosity lubricants produced low extrusion load and friction during metal forming process with no major severe wear on product quality. Based on the results, it was proven that renewable resource based lubricants can be considered as a substitute for common lubricants used in the industry, since they present similar results with those currently applied in the industry.

**Keywords:** Cold extrusion, non-renewable, renewable, metal forming lubricants, plant-based oil

### Abstrak

Pelinciran dalam proses membentuk logam adalah sangat penting bagi mengawal kadar kehausan dan geseran di antara permukaan yang bersentuhan. Minyak mineral biasanya digunakan secara meluas kerana kemampuannya yang berfungsi sebagai bahan filem untuk mengekalkan transformasi kimia. Oleh kerana sumber-sumber yang tidak boleh diperbaharui ini hanya boleh bertahan selama lebih daripada satu dekad dari sekarang, sumber yang boleh diperbaharui telah dikaji sebagai pelincir alternatif yang boleh memberikan impak yang sama dari segi beban minimum ketika proses penyemperitan dan kualiti produk. Dua pelincir boleh diperbaharui dianalisis (RBD palm olein dan jatropa) bersama-sama dengan minyak mineral sedia ada, PMO VG32. Berdasarkan kepada keputusan, ia telah terbukti bahawa pelincir berasaskan bahan boleh diperbaharui boleh dipertimbangkan untuk menggantikan minyak pelincir sedia ada di industri.

**Kata kunci:** Penyemperitan sejuk, yang tidak boleh diperbaharui, boleh diperbaharui, logam membentuk pelincir, minyak berasaskan tumbuhan

© 2015 Penerbit UTM Press. All rights reserved

## 1.0 INTRODUCTION

Exploration for natural resources such as minerals, forest, petroleum and natural gas is a significant pursuit for a country's development. Industrial development, transportation sectors and municipalities are but a few reasons that accelerate the exhaustion of fuel resource supplies. As such, all these activities need to be done sustainably in order to achieve economic development, and at the same time, still preserving the environment.

Mineral natural resources are considered as non-renewable resources. It takes millions of years to produce; with continuous exploration practices, it can only last for another 40 years onwards. Therefore, a few alternatives have been identified and studied to address the resource depletion issue. With regards to the performance and quality of the alternatives, there is hope that it can perform as good as natural minerals.

### 1.1 Lubrication in Metal Forming

Basically, the purpose of lubrication is to control wear and friction at the interface between interacting surfaces [1,2]. Lubrication acts as a supplier in the form of either gas, liquid or solid powder to the wearing contact, where it functions as film materials or sustains chemical transformations to become film materials.

Lubrication is very important in cold extrusion of metals, mainly because it is related to the reduction of extrusion loads and tool wear. Lubrication processes and usage in industries are time consuming and incurs high costs with significant environmental impact. Typical examples are plain mineral oil, which directly produces liquid film; solid lubricants such as molybdenum disulphide and also additives in lubricating oil that chemically react with the surface to form film material [3].

Types of metal forming lubricants in commercial uses can be classified [4] as follows:

- i. aqueous dispersions (soap/water type, soap/fat emulsions, soluble oil emulsions, etc.); oil type fluids (mineral/fat oils, chemical active oils, oil/wax fluids);
- ii. solid lubricants (oxides, phosphate, derived from chemical solutions, etc.); and metallic solids (hot-dipped or sprayed coatings of copper, tin, lead, etc.).

To reduce friction and wear, which generally affect tool life, metal flow, energy consumption, heat evolution and surface finish, metal forming lubricants are applied to the tool-work interface in many metal forming operations. The development of friction between the work piece and punch or dies in metal forming processes becomes a major processing parameter. Surface finish and dimensional precision of the product are directly related to friction. Since the benefits of friction and lubrication control can be immense in metal forming, especially cold forming, considerable effort has been directed to the measurement of friction for both general metal

working conditions and specific metal working processes so far [5].

Factors that affect the selection of the types of lubricants include the operation, tooling, raw materials; not to mention, the application method of the lubricant, subsequent operations and other special considerations. The types of oil-based lubricants include mineral oils, mineral fatty oils, mineral fatty chlorinated oil, mineral fatty sulfur oil, mineral fatty chlorinated oil, metallic soaps, and phosphate esters. Water-based extendible lubricants include mineral soluble oils, fatty soluble oils, fatty chlorinated soluble oil, fatty sulfur soluble oil, fatty chlorinated sulfur soluble oil, liquid soap, soap fat paste compound, and synthetics". Recent trends include using film lubricants and even the elimination of lubricants in response to increasing environmental concerns and in an effort to reduce costs [6].

### 1.2 Alternative Lubricants for Metal Forming Process

Over the past century, metal forming lubricants are based on mineral oils. This has been proven that by using mineral oils, it is able to produce quality products as needed by the customers. As mentioned before, resource depletion has become a major issue for industries that try to maintain mineral oil usage in the next century. Upon considering resource depletion as a global issue, researchers from all over the world have begun to study on the alternatives to substitute this non-renewable lubricant with renewable lubricants. Among the possible choices are various types of vegetable oils such as palm oil, jatropha oil, corn oil, sunflower oil, etc. Vegetable oils have been categorized as a renewable resource because as long as trees are still planted, the resource will remain available.

Caminaga *et al.* [7, 8] had successfully done an experiment using various types of potential lubricants and found that the surface roughness and the dimensional quality of the products extruded with these alternative lubricants are similar to those found in the standard tests. M. Lovell *et al.* [9] discovered that boric acid and canola oil lubricants have substantial potential to provide the manufacturing community with a commercially viable and environmentally friendly alternative that will allow the forming of complex parts.

Wheat flour lubricant was selected by Hirofumi *et al.* [10] to develop a non-polluting lubricant for the sheet metal-forming process. The result turned out successful where the sheet coated with wheat flour had a higher formability than the sheet coated with press oil.

The introduction of environmental legislation series by Occupational Safety & Health Administration (OSHA) and other international regulation authorities has force the manufacturing sector to reduce the consumption of mineral oil-based metal working fluids. There is a huge potential for utilizing vegetable oils as cutting fluids in the manufacturing sector as shown in Table 1. For example, rolling is a complex process from a

tribological point of view and palm-oil is still preferred as a lubricant for cold rolling.

**Table 1** Advantages and disadvantages of vegetable oils as lubricants

Advantages	Disadvantages
Possess qualities of metal working fluids	Low thermal stability
High biodegradability	Oxidative stability
Less pollution towards the environment	High freezing points
Compatible with additives	Poor corrosion protection
Low production costs	
Wide production possibilities	
Low toxicity	
High flash points	
Low volatility	
High viscosity indices	

**Table 2** Potential applications for various vegetable oils

Vegetable/Animal oil	Common application
Olive oil	Automotive lubricants
Sperm oil	Spindle lubricant in textile mills, automotive transmission fluids, metal cutting fluids, instrument oils
Rapeseed oil	Metal forming processes. Chain saw bar lubricants, air compressor-farm equipment, Biodegradable greases.
Castor oil	Gear lubricants
Coconut oil	Used for compounding gas and petrol engine oils
Palm oil	Used for steel industry for rolling thin gauge strip, railway wagon greases
Tallow	Used for compounding steam cylinder oils
Canola oil	Hydraulic oils, tractor transmission fluids, metal working fluids, food grade lubes, penetrating oils, chain bar lubes

Since 1939, various types of vegetable oils including palm oil were used as lubricants, which is not surprising. Some of the commonly used vegetable oils are listed in Table 2. Unfortunately they are limited by their poor low-temperature fluidity and poor oxidative stability at high temperatures. The most desirable oil for lubricants are oils with a high percentage of mono saturated fatty acids, moderate amount of polyunsaturated fatty acids and low amount of polyunsaturated fatty acids and low amount of saturated fatty acids.

This study was conducted to study the alternatives for mineral based lubricants in metal forming by considering a few aspects of the extrusion products

including the extrusion load, surface roughness, velocity and others. Hopefully, this present work would help to promote the application of renewable natural resources as well as to protect the environment.

## 2.0 METHODOLOGY

### 2.1 Procedure

The experimental set-up of the plain strain extrusion apparatus is depicted in Figure 1(a). The main components are the container wall, taper die and

work-piece (billet). This experiment was done with a laboratory press machine at room temperature. This plain extrusion apparatus was assembled and placed on the load cell to record the load extrusion (Y-axis) during each test. The displacement of the ram stroke (X-axis) was also recorded by using the displacement sensor, which is attached to the holder of the plain extrusion apparatus. Extrusion was stopped at a piston stroke of 35 mm, where the extrusion process was expected to reach steady state condition. The ram speed was constant at 7.6 mm/s. The lubricant was applied onto the taper die (surface that is in contact with the billet) before the test. The billets were cleaned using acetone. During the extrusion process, the two similar billets were stacked and used as one unit of billet that was fixed on a container and extruded through a pair of taper dies. After the experiment, the partially extruded billets were taken out from the plane extrusion apparatus; surface roughness of the billet with the observation plane was measured and the extrusion load was analyzed.

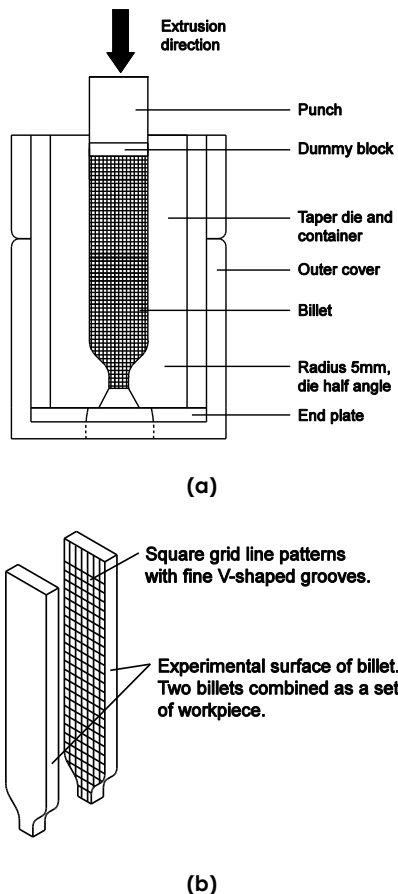

**Figure 1(a)** The schematic sketch of the plane strain extrusion apparatus and **(b)** combination of billets

## 2.2 Apparatus

The experimental set-up of the plain strain extrusion apparatus consists of several main components,

namely, the container wall, taper die and work piece (billet). The taper die has a radius of 5 mm, die half-angle. The taper die is made from tool steel (JIS-SKD11), and necessary heat treatments were performed before the experiments. The experimental surfaces of taper dies (surface in contact with the billet) were polished with abrasive paper and have surface roughness,  $R_a$ , of approximately 0.15  $\mu\text{m}$ . The Vickers hardness of the taper die was 650 Hv. A specified amount of lubricant was applied to this surface before the experiments. The other surfaces of the experimental apparatus have the same type of test lubricant applied.

Figure 1(b) shows a schematic sketch of the billets used in the experiments. The billet material is pure aluminum (JIS-A1100). The billets' shape was formed by an NC wire cut electric discharge machining device. Two similar billets were stacked and used as one unit of billet. One side of the contact surface of the combined billets was the observation plane of the plastic flow in plane strain extrusion. The observation plane was not affected by the frictional constraint of the parallel side walls. A square grid pattern measuring the material flow in the extrusion process was scribed by the NC milling machine on the observation plane of the billet. The grid lines were V-shaped grooves with 0.5 mm depth, 0.2 mm width, and 1.0 mm interval length. The billets were annealed before the experiments. Annealing gives the best condition for cold forming due to the presence of ferrite in its microstructure [11].

## 2.3 Tested Lubricants

The tested lubricants consist of 2 types of renewable oil – palm olein and jatropha oil. A type of cooking oil, partly of oil formulations for shortening, margarine and other uses are also known as RBD palm olein in the palm oil industry. RBD represents Refined Bleached Deodorized, which means that the oil has gone through a purifying process to dissipate unnecessary fatty acids and odour. This process is followed by a fractionation process to extract the palm olein. RBD palm olein is the liquid fraction acquired from fractionation of palm oil. It is fully liquid at ambient temperature in warm climates. Since palm oil production is vital for Malaysia's economy, finding research into its various applications is pertinent and practical.

*Jatropha curcas* grows well in marginal or poor soil. It produces seeds with an oil content of 37%. The seeds of *jatropha* contain viscous oil, which can be used in the manufacturing of candles and soaps for the cosmetics industry. Its wood and fruit can be used for numerous purposes including fuel (Kumar and Sharma, 2008). The first attempt to introduce commercial farming of *Jatropha* was in 2003 and since then it has become a platform for multidisciplinary methods involving multiple feedstock research into all aspects of nonfood energy farming. *Jatropha* can be grown in all countries falling under tropical, subtropical zones and in certain countries

that fall within temperate climate [12]. Jatropha is rather new in Malaysia and widely used in bio-diesel application. Thus, it would be a valuable finding if jatropha can be proven as an alternative lubricant for metal forming processes.

Additive free paraffinic mineral oil VG32 will act as the reference lubricant to determine its similarities, through comparison, to an extent where it could become a potential alternative for metal forming lubricants in the future. The lubricant's viscosity index values are slightly lower due to its liquidity condition as presented in Table 3. Since the viscosity index values between all the tested lubricants are more or less the same, it is rather important to identify which lubricant is rather significant among each other.

**Table 3** Mechanical properties of tested lubricants.

Mechanical Properties	Renewable		Non-renewable
	Palm Olein	Jatropha	Mineral Oil VG32
Relative Density, $\rho$	0.85	0.9	0.86
Viscosity Index	258	350	368
Kinematic Viscosity, $\text{mm}^2/\text{s}$	40°C	35.78	38.21
	100°C	9.22	12.81
			24.15
			8.5

All the values in Table 3 have been tested by the researcher using a Cole-Parmer Viscometer VCPL 300003. 250 ml of lubricant was measured and heated by a heater until it reached 100°C. Then, the heater was switched off to allow the tested lubricant to cool slowly. All the data were recorded by software according to a programmed database. One drop of lubricant (approximately 15 mg) was applied on the experimental surface of the taper die before the experiment. The initial lubricant amount was predicted to create a full film lubrication regime at an early stage of the extrusion process.

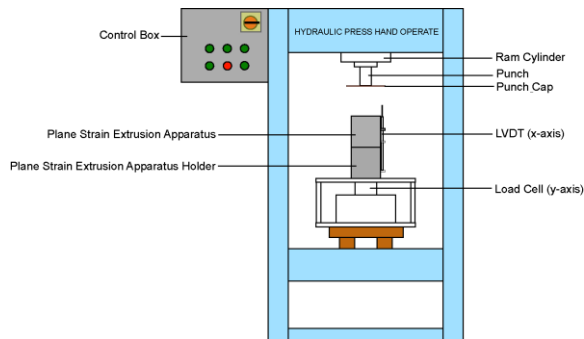

**Figure 2** Schematic sketch of the hydraulic press machine used in the experiments

**2.4 Procedures**

The plane strain extrusion apparatus was assembled and placed on the press machine as shown schematically in Figure 2. The forming load and

displacement data were recorded by computer. The experiments were carried out at room temperature. Extrusion was stopped at a piston stroke of 35 mm with speeds around 2.4 – 5.0 mm/s. The ram hydraulic pressure is constant at 120 bars. After the experiment, the partially extruded billets were taken out from the plane strain extrusion apparatus and the combined billets were separated for surface roughness measurement and observation via microscope.

**3.0 RESULTS AND DISCUSSION**

**3.1 Extrusion Load**

The extrusion load-piston stroke clustered bar is shown in Figure 3. The figure shows the maximum extrusion load during the process; the extrusion process reached steady state condition at a piston stroke of 15 mm onwards. Along the process, as the piston stroke reached 35 mm, the maximum extrusion value for jatropha, RBD palm olein and VG32 were 120.129 kN, 79.953 kN and 98.61 kN, respectively. In addition, RBD palm olein and VG32 loading time were quite the same, where they managed to finish the process approximately one second earlier than jatropha as illustrated in Figure 4.

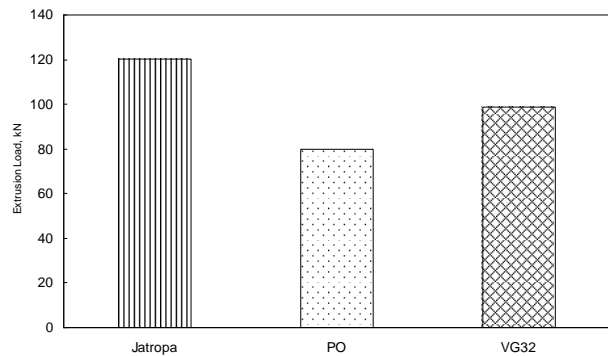

**Figure 3** Extrusion load-piston stroke curves

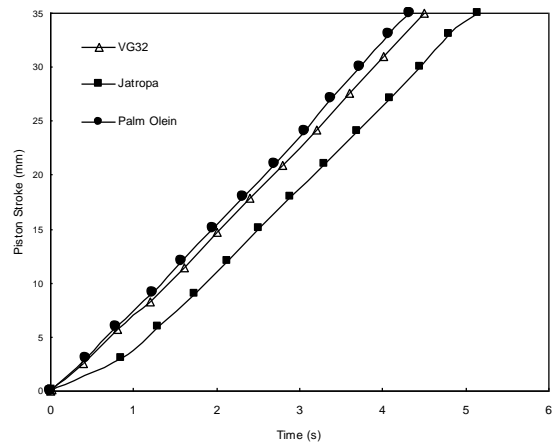

**Figure 4** Piston stroke-time curves

A few researches had been done, which proved that VG32 is among the preferable mineral based lubricants for metal forming process, especially cold extrusion processes. Consistent with the findings by Syahrullail *et al.* [13, 14], the palm olein extrusion load value is almost the same as VG32 when compared to jatropha. In addition, the viscosity index values of both lubricants are almost similar, where palm olein is 258 and VG32 is 368. Corresponding to that physical condition, it will result in less friction and less extrusion loads during the extrusion process. RBD palm olein has a composition of oleic acid that would help in reducing sliding friction [15], in such a way that lesser metal-to-metal contact between the billet and taper die was observed [7]. Jatropha seems to have more contact and this proves that when more metal-to-metal contact occurs, the process needs more energy to shear the material and thus making the extrusion load higher.

As found by Emil A. *et al.* [16], jatropha has 2.23% of free fatty acids (FFA), which is obviously different from RBD palm olein, with less than 0.1% of FFA. According to L. Yingying *et al.* [17], with the increase of FFA, the yield of glycerol decreases slightly. Glycerol would normally react together with fatty acids to create a thin layer between the sliding actions. This is to reduce friction, wear and extrusion load. The more glycerol and fatty acid, the thicker the layer will exist.

### 3.2 Surface Roughness

The distributions of arithmetic mean surface roughness, Ra along the experimental surface billet (sliding plane) were measured with a surface profiler device. The experimental surface is defined as the surface of billet that is in contact with taper die and the container during the extrusion process. The measurement direction is perpendicular to the extrusion direction. The distribution of arithmetic mean surface roughness, Ra is shown in Figure 5.

The billet's surface that has contact with taper die and container wall is the experimental surface area. It was labelled as the x-axis. Along the surface, there are five major points that were measured. Point 1 is labelled 0 mm, where the extrusion process was just finished (no metal-to-metal contact area). Point 2 represents the deformation area whereby the 6 mm, 8 mm and 10 mm points were located accordingly. Meanwhile, Point 3 is the area where the billet is still maintaining its original size (undeformed area).

From the beginning of extrusion process, jatropha's roughness value seems be the highest followed by jatropha and palm olein. Jatropha shows the highest value with a 0.05-0.15  $\mu\text{m}$  difference with RBD palm olein and VG95. Physically, RBD palm olein is the least viscous lubricant compared to jatropha and has higher possibilities to supply the lubricant until 0 mm. This differs with jatropha in which the lubricants tend to stay at the surface of contact area due to their high concentrated physical attributes. The Ra value was slightly higher from the beginning of the process towards the end. Nevertheless, the differences

between each lubricant were obviously small and from the observation by CCD camera, as illustrated in Figure 6, no severe wear occurred.

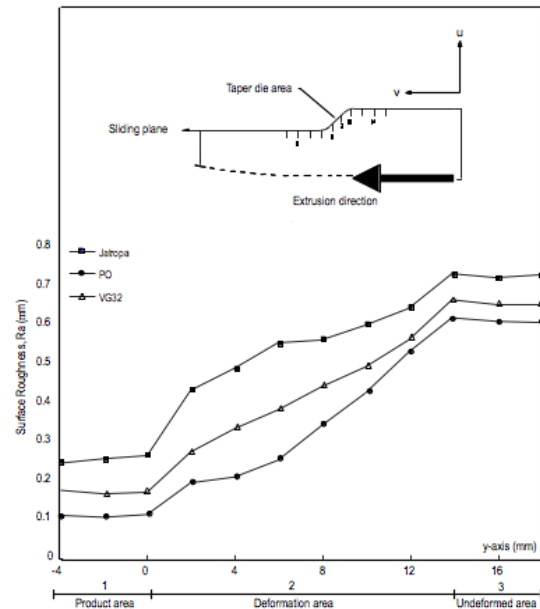

Figure 5 Surface roughness distribution on the experimental surface of billet (deformation area)

### 3.3 Relative Sliding Velocity

The velocity component of the billets that slides on the taper die's surface was obtained from data tracing and calculated using the Visio plasticity method. In order to acquire the relative component velocity, the velocity component values were divided with the ram speed,  $V_0$ .

Comparison of the relative velocity for  $v$ - (horizontal direction velocity) and  $u$ - (vertical direction velocity) of the plastic flow velocities along the experimental surface of the billet are shown in Figure 7 and Figure 8, respectively. Meanwhile, for the resultant relative sliding velocity, which was calculated using Equation 1, is as plotted in Figure 9. Since this involves two velocity directions,  $u$  represents the relative  $u$ -component velocity and  $v$  represents the relative  $v$ -component velocity. Figure 10 is the illustration of the resultant velocity that was generated by using Visio plasticity method.

$$\text{Resultant sliding velocity} = \sqrt{u^2 + v^2} \quad (1)$$

Lesser load and lesser friction will result in higher velocity of sliding action. As shown in Figure 8, RBD palm olein tends to have a higher sliding velocity when compared to jatropha. Previous discussions on extrusion load shows equivalence with this outcome, where the extrusion process using RBD palm olein as lubricant, requires more velocity to slide during the

deformation process and is due to less metal-to-metal contact between the billet and the taper die that leads to low extrusion load usage and low friction effect [18].

**3.4 Flow Line Observation**

It is important to study the behavior of the billet's extruded metal flow in this experiment in order to add value, and thus supporting the existing findings. Therefore, the horizontal flow lines of the extruded billet were compared by measuring the flow line angle using a microscope. The measurement distance starts from product area (0 mm) until the undeformed area (14 mm), which is represented by the x-axis. In order to obtain the percentage, each billet's gridlines within the measurement area were measured and the value was plotted against the y-axis. Figure 11 presents the comparison of the flow line angle percentage for each lubricant.

As plotted in Figure 11, the angle percentage in the deformation area is significant and varies from other areas, especially in the range of 6 – 8 mm. Jatropha creates high friction between the tool and billet surface, resulting in a smaller flow line angle as the metal flows to both sides of the billet. High friction may cause the billet to deform more than usual during the extrusion process. By comparing this finding with the sliding velocity result, it proved that jatropha has more metal-to-metal contact as the result was the lowest compared to the other lubricants.

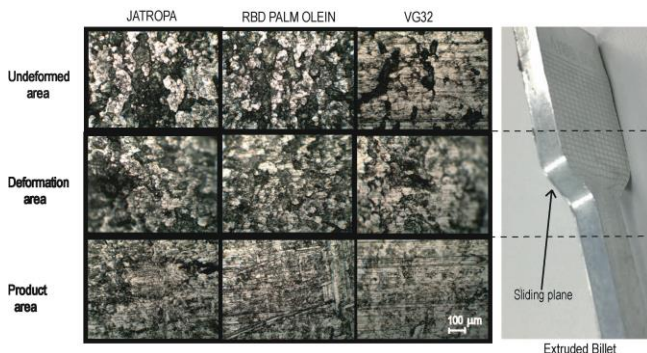
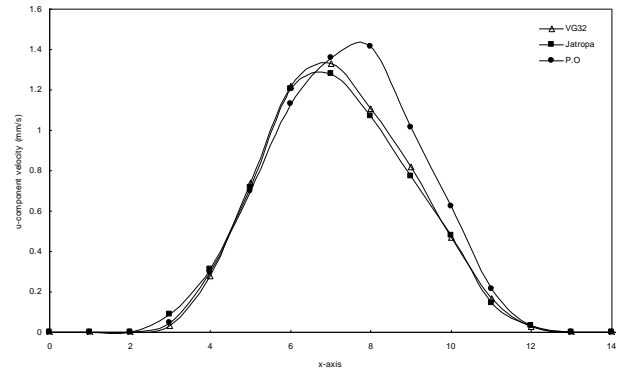

**Figure 6** CCD image of sliding wear in 20x magnification for extruded billets

**3.5 Effective Strain,  $\epsilon_{eff}$**

Figure 12 shows the effective strain,  $\epsilon_{eff}$  for the tested lubricant; the result calculated using the Visio plasticity method was used to map out the distribution of strain and strain rate. The variation of effective strain with respect to distance from the center to the periphery of the billet in the axial direction was clearly visualized. In deformation area, jatropha's effective strain value was more than RBD

palm olein and VG32. As mentioned in the previous analysis, jatropha has higher friction thus resulting in lower sliding velocity than palm olein. For this reason, the jatropha elongation rate was 0.5 lesser than palm olein. As in the experiment done by R. Ganesh [19], higher liquidity of the lubricant results in greater hold ability during the operation. This is in line with this experiment where the palm olein viscosity value was less than jatropha.



**Figure 7** u-component velocity distribution along the experimental surface of billet

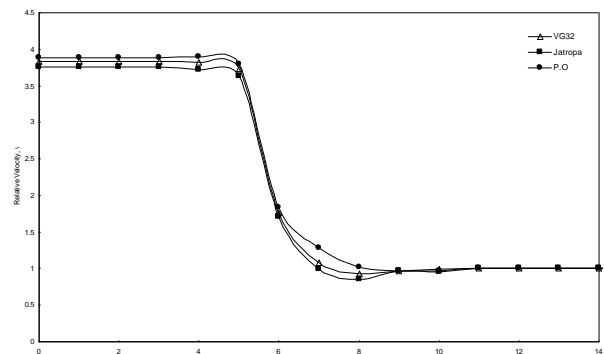

**Figure 8** v-component velocity distribution along the experimental surface of billet

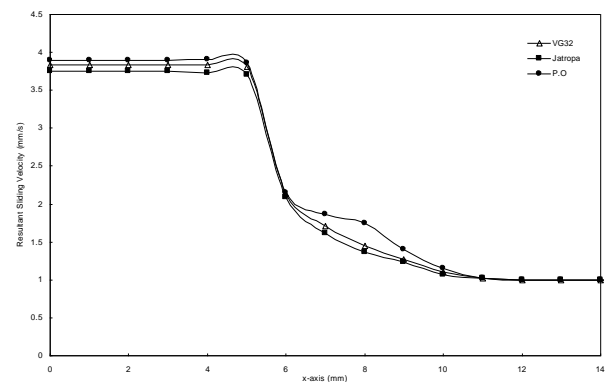

**Figure 9** Sliding velocity of extruded billet

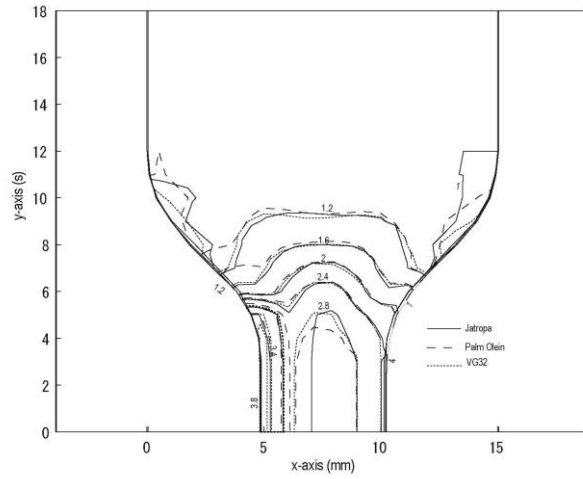

Figure 10 Resultant velocity distribution contour in extruded JIS-A1 100 billet tested lubricants

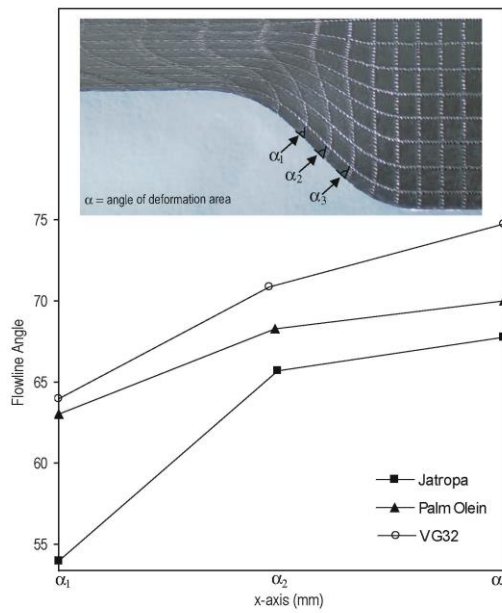

Figure 11 Comparison of flow line observation of the the tested lubricants

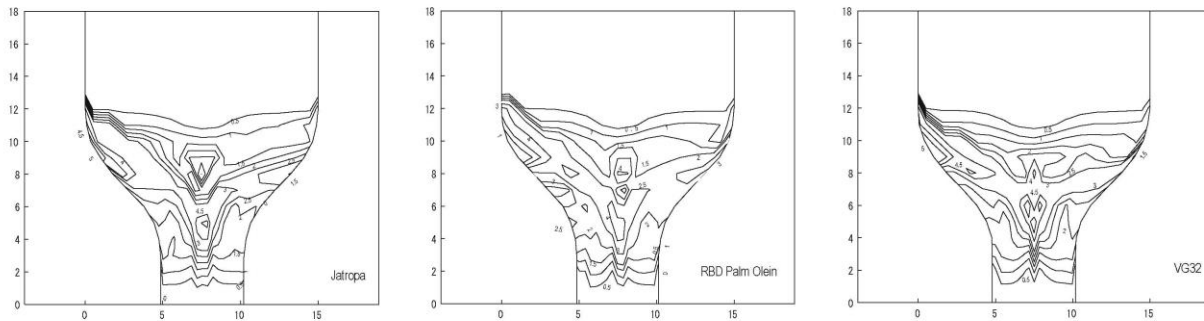

Figure 12 Effective strain contour of tested lubricants



## 4.0 CONCLUSION

With the main purpose to find alternatives for mineral based lubricants in metal forming process, this study was successfully done using a cold work plane strain extrusion process on JIS-A1100 pure aluminum billet. The alternative lubricant has been chosen among the two types of renewable lubricants – palm olein and jatropa. The results showed that the high viscosity of the renewable lubricant tends to have similar attributes with the recommended non-renewable lubricant in terms of lesser extrusion loads and lesser friction conditions. With the viscosity index value of 258, palm olein has low metal-to-metal contact between the billet and the taper die. As such, more sliding velocity is needed during the extrusion process. However, there is no obvious difference in surface quality from the surface roughness findings and observation of the product area surface.

## Acknowledgement

The authors wish to thank the Faculty of Mechanical Engineering, Universiti Teknologi Malaysia for their support and cooperation during this study. The authors also wish to thank Research Management Centre (RMC) for the Research University Grant (02G34, 02G35) from Fundamental Research Grant Scheme (4F229, 4F610), Universiti Teknologi Malaysia and E-Science Grant from the Ministry of Education of Malaysia for their financial support.

## References

- [1] Z. Wenwu. 2013. *Intelligent Energy Field Manufacturing: Interdisciplinary Process Innovations*. Boca Raton.
- [2] Z. Hongbo. 2011. *Polymer Adhesion, Friction and Lubrication*. John Wiley & Sons.
- [3] W. S. Gwidon, W. B. Andrew. 2014. *Lubricants and Their Composition*, Engineering Tribology. forth ed. Elsevier Publications.
- [4] E. L. H. Bastian. 1968. *Lubrication Principles in Metal Drawing, Forming and Rolling*. Mc-Graw Hill.
- [5] K. H. Jung, H. C. Lee, S. H. Kang, Y. T. Im. 2008. Effect of Surface Roughness on Friction in Cold Forging. *Journal Achievements Material Manufacturing Engineering*. 13: 327-334.
- [6] B. Suddhasatwa. 2007. *Future directions of Fuel Cell Science and Technology Recent Trends in Fuel Cell Science and Technology*. Springer, New York. 356-365.
- [7] C. Caminaga, L. Rafael, S. T. Button. 2006. Alternative Lubrication and Lubricants for the Cold Extrusion of Steel Parts. *Journal Material Processing Technology*. 179: 87-91.
- [8] C. Caminaga, F. Ozanan Neves, C. Fernando, B. S., Tonini. 2007. Study of Alternative Lubricants to the Cold Extrusion of Steel Shafts. *Journal Material Processing Technology*. 182: 432-439.
- [9] M. Lovell, C. F. Higgs, P. Deshmukh, A. Mobley. 2006. Increasing Formability in Sheet Metal Stamping Operations Using Environmentally Friendly Lubricants. *Journal Material Processing Technology*. 177: 87-90.
- [10] Y. Hirofumi, T. Shigeyoshi, N. Toshihumi, N. Toshiji, I. Naoyoshi. 2002. Application of Wheat Flour Lubricants to the Press-Forming Process. *Journal Material Processing Technology*. 125-126: 375-378.
- [11] M. Janosec, V. Schindler, V. Vodarek, J. Palat, S. Ruz, P. Suchanek, M. Ruzicka, E. Mistecky. 2007. Microstructure and Mechanical Properties of Cold Rolled, Annealed HSLA Strip Steels. *Archives of Civil and Mechanical Engineering*. 8(2): 29-38.
- [12] The Plant-Profile, About Jatropa Plant. Building A Sustainable Biodiesel Industry. <http://www.jatropabiodiesel.org/>. Retrieved on 12 May 2014.
- [13] S. Syahrullail, C. S. N. Azwadi, W. B. Seah. 2009. Plasticity Analysis of Pure Aluminum Extruded with an RBD Palm Olein Lubricant. *Journal Applied Science*. 9: 19.
- [14] S. Syahrullail, S. Kamitani, K. Nakanishi. 2012. Experimental Evaluation of Refined, Bleached, and Deodorized Palm Olein and Palm Stearin in Cold Extrusion of Aluminum A1050. *Tribology Transactions*. 55(2): 199-209.
- [15] I. T. Chiong, A. K. M. Rafiq, Y. Azli, S. Syahrullail. 2012. Tribological Behaviour of Refined, Bleached and Deodorized Palm Olein in Different Loads Using Four-Ball Tribotester. *Scientia Iranica*. 19(6): 1487-1492.
- [16] A. Emil, Y. Zahira, K.K. Siti, I. Manal, S. Jumat. 2009. Characteristic and Composition of a Jatropa Curcas Oil Seed from Malaysia and Its Potential as Biodiesel Feedstock. *Journal European Scientific Research*. 29(3): 396-403.
- [17] L. Yingying, L. Houfang, J. Wei, S.L. Oong, L. Shijie, L. Bin. 2012. Biodiesel Production from Crude Jatropa Curcas Lubricant Oil with Trace Acid Catalyst. *Chinese Journal Chemical Engineering*. 20(4): 740-746.
- [18] S. Syahrullail, C. S. N. Azwadi, M. R. Abdul Kadir, N. E. A. Shafie. 2011. The Effect of Tool Surface Roughness in Cold Work Extrusion. *Journal Applied Science*. 11: 367-372.
- [19] N. R. Ganesh, M. Gopal, A. Rajadurai. 2008. Influence of Friction in Simple Upsetting and Prediction of Hardness Distribution in a Cold Forged Product. *Journal Testing Evaluation*. 36: 4.