

MULTIBAND CPW-FED SLOT ANTENNA FOR WLAN/WIMAX APPLICATIONS

Igbafe Orikumhi^{a*}, Mohamad Rijal Hamid^a, Ali Nyangwarimam Obadiah^a

Department of Communication Engineering, Faculty of Electrical Engineering, Universiti Teknologi Malaysia, 81310 UTM Johor Bahru, Johor, Malaysia

Article history

Received
30 March 2015
Received in revised form
14 November 2015
Accepted
15 November 2015

*Corresponding author
johnorikumhi@yahoo.com

Graphical abstract

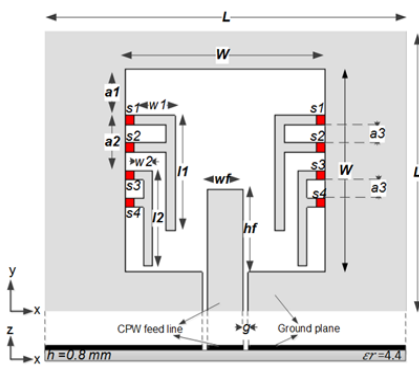

Abstract

A square slot antenna fed by a coplanar waveguide (CPW) is presented in this paper. The design consist of two pairs of "F" shaped planar strips placed within a square slotted ground. The strips are used to excite multiple resonant frequencies, the strips are connected to the ground plane by means of ideal switches. The proposed antenna has achieved multiple resonant frequencies of 2.4/5.2/5.8 GHz for WLAN and 3.5/5.5 for WiMAX applications. The measured results shows a good agreement with the simulated results in terms of return loss, radiation pattern and gain. The proposed antenna is designed for the frequency range of 2 GHz to 7 GHz which makes it suitable for Bluetooth, WLAN and WiMAX applications.

Keywords: Multiband antenna, Coplanar waveguide, WLAN, WiMAX

Abstrak

Sebuah antena slot segi empat dengan suapan pandu gelombang sesatah (CPW) dibentangkan dalam kertas ini. Reka bentuk ini mengandungi dua pasang jalur berbentuk "F" di dalam slot empat segi. Ia digunakan untuk menghasilkan pelbagai frekuensi salunan, jalur ini boleh diputus dan disambung kepada slot segi empat melalui suis ideal. Antena yang dicadangkan telah mencapai pelbagai frekuensi salunan 2.4 / 5.2 / 5.8 GHz untuk WLAN dan 3.5 / 5.5 untuk aplikasi WiMAX. Hasil pengukuran menunjukkan satu perijetujuan yang baik dengan hasil simulasi dari segi kehilangan masukan, corak sinaran dan gandaan. Antena yang dicadangkan direka untuk julat frekuensi 2 GHz hingga 7 GHz yang menjadikan ia sesuai untuk aplikasi Bluetooth, WLAN dan WiMAX.

Kata kunci: Pandu gelombang sesatah, WLAN, WiMAX

© 2015 Penerbit UTM Press. All rights reserved

1.0 INTRODUCTION

Communication systems have experienced a lot of improvements in recent years, leading to more services and standards such as wireless local area network (WLAN), Worldwide Interoperability for Microwave assess (WiMAX) and Bluetooth. Modern technology combines some of these standards into a single device.

Hence, the need for antennas that can operate on different standards and application are vital.

In current wireless system, antennas with wideband and multiband characteristics are becoming more desirable, as they can span several range of frequencies. However they require good filters to achieve less out-of-band noise [1]. Examples of wideband and multiband antenna, are presented in [2-4]. In general, a simple method used to obtain multiple

frequency bands is the use of several monopoles. However, larger sizes are required for monopoles operating in the lower frequencies, leading to large antenna sizes. Several methods have been proposed to reduce the sizes of the monopoles to a more compact size [2]. Reconfigurable antennas offer promising advantages over non reconfigurable antenna with narrowband to narrowband reconfiguration. However, reconfigurable antennas fail to provide simultaneous operations at a time. In recent studies, reconfigurable multiband antennas have received good attention [5-7]. To reduce the sizes, when using monopoles, spiral strips have been proposed [8-10]. In [8], the author proposed a bent structured dipole to keep the size of the antenna small, in addition a spiral strip was printed below the feed point to excite higher band of frequencies. The results show that making the size of an antenna small while maintaining multiple frequencies is possible. However, there is a tradeoff in the antennas structure complexities. In [11], the author proposed dipole slot antenna, where the antenna achieves triband, dual band and single band switching by using step impedance. The antenna was designed for narrow and broadband applications, the results showed good return loss.

In this paper, we present a simple compact coplanar waveguide (CPW) fed slot antenna for WLAN/WiMAX applications. The choice of CPW feeding can be observed in its numerous advantages it exhibit over the microstrip counterparts. These advantages ranges from small size, good performance, low cost, light weight, low profile, easy to fabricate and install, low depression and low radiation loss. In addition, the CPW feed also exhibit wider bandwidth compared to the microstrip antennas. The propose antenna mainly comprises of two pairs of 'F' planar strips, placed within a slotted ground. The shorter ends of the strips are connected to the ground plane by coupling and decoupling with the use of perfect conductors. The antenna is designed for 2.4/5.2/5.8 GHz for WLAN and 3.5/5.5 for WiMAX applications.

2.0 ANTENNA STRUCTURE

Figure 1, shows the geometry of the proposed antenna. The design is based on [3] which is composed of a square ground slot fed by a coplanar waveguide (CPW) feed line. However, to increase the numbers of switchable frequencies and improve the matching, two pairs of 'F' shaped planer strips are placed within the slot. The upper pair of F strip with a length of $l1$ mm, is placed $a1$ mm from the top of the slot, the second pair of F strip with length $l2$ mm is placed at $(a1 + a2)$ mm from the top of the slot. Both strips are coupled to the

slotted ground plane by switches. The antenna is fed by a 50Ω CPW feed line of length hf mm. There are four pairs of switches used to produce sixteen switch modes. The presence/absence of a perfect conductor was used to define the on/off states of the switches respectively. The design was carried out on a flame retardant IV (FR4) substrate with permittivity of 4.4 and height 0.8 mm. The antenna has a size of $L \times L$ mm with and $W \times W$ mm slot. A switch gap of 1×1 mm is placed between the F strip and the ground, the switches are labelled $s1, s2, s3$ and $s4$.

Each of the F strip provide two positions from which they can be coupled or decoupled from the structure. Hence, the electrical length of the strips can be varied and the frequency can be reconfigured.

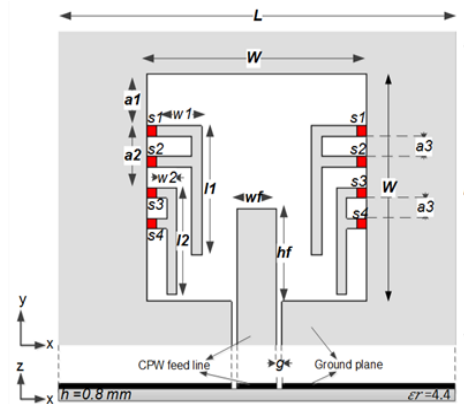

Figure 1 Proposed antenna structure

Table 1, shows the optimized antenna parameters with all measurement in millimeters (mm). Computer Simulation Technology (CST) software was used for the performance analysis of the antenna.

In other to investigate the effect of the F planner strips, seven modes are fabricated from the available sixteen states. For easy referencing, the fabricated modes configuration are presented in table 2. The structure with no strip in it, is used as reference antenna, while seven modes are designed with F planar strip placed within the slot. The strips are coupled to the ground by means of ideal switches, i.e. a perfect conductor is used between each pair of F planner strip and the ground, depending on the switch configuration. First, we investigate the height of the feed line, by varying hf . From Figure 2a, it can be observed that, the frequency goes to the lower band when the height of the feed line increases.

Table 1 Optimized antenna parameters

L	W	a1	a2	a3	g	w1	w2	wf	hf	l1	l2	L	h
40	22	5	6	2	0.5	2.8	5.5	4	9	12.5	10.3	40	0.8

When $hf=13$ mm, the reference antenna demonstrate a narrow band design with bandwidth of 17.14% at 3.5 GHz. However, $hf=9$ mm, is chosen for the design because of the high impedance bandwidth.

Table 2 Switch modes configuration

Mode	Switch configuration			
	s4	s3	s2	s1
0	OFF	ON	OFF	ON
1	ON	ON	OFF	ON
2	ON	ON	ON	ON
3	OFF	OFF	OFF	ON
4	OFF	OFF	ON	ON
5	ON	ON	OFF	OFF
6	OFF	ON	ON	OFF

Figure 2b shows the result when the strips are placed within the slots, however the strips are decoupled from the ground plane, i.e. all switches are in the off state mode. It can be observed that, when the F planner strips are placed within the slot, a new frequency band is excited at center frequencies of 3.5 GHz and 6.48 GHz and bandwidth of 14.3% and 9.4% respectively.

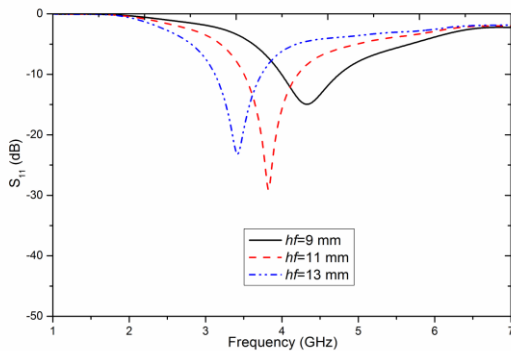

Figure 2a Simulated result with varying the height of the feed line without the F planner strips.

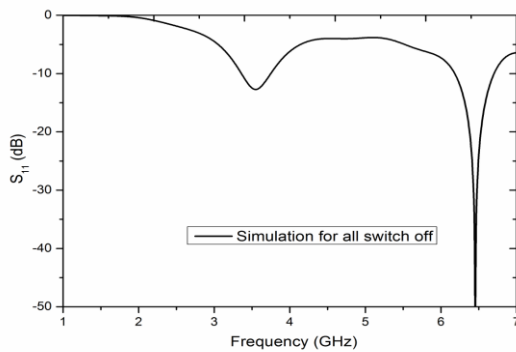

Figure 2b Simulated result, height of feed line is chosen to be $hf=9$ mm while all the F strips are place within the slots with all switches in off state.

The length of the strips $l1$ and $l2$ can be properly adjusted to obtain the desired frequency for WLAN and WiMAX applications. This can be observed when the switch configuration is set to mode 0 as shown in table 2. The bandwidth of 120MHz, 110MHz and 800MHz are obtained, the obtained frequency band fully covers 2.4/5.2/5.8 GHz bands for WLAN applications and 3.5/5.5 GHz for WiMAX applications. However, due to adjacent channel interference in wireless network only part of the frequency band might be required at a time. Hence, the behavior of the strips within the slots are studied in the following section, to enable proper selection of only the switching mode required to avoid co-channel interference.

3.0 RESULTS AND DISCUSSION

In other to verify the performance of the antenna, seven prototype are fabricated with the optimized parameters in table 1 and various switch configurations as presented in table 2. Mode 0, mode 1 and mode 2 are grouped together, as they each resonate at three different frequencies. By coupling both pairs of F strip to the ground plane, the proposed antenna mode operates in tri-band mode as shown in Figure 3. When the upper and the lower F strip is coupled to the ground, each F strip excites a different frequency band. However due to mutual coupling between the strips, if $a3$ is quite small the matching could be poor. Coupling $s1$ and $s3$ to the ground plane while $s2$ and $s4$ are decoupled as presented in mode 0, the antenna resonate at centre frequencies of 2.4, 3.4 and 5.8 GHz, with S_{11} at -18dB, -20.4dB and -14.5dB respectively. It can be observed from mode 0 and mode 1 that, when only the $s1$ is coupled and $s2$ is decoupled the upper arm resonate at 2.4 GHz. Also by coupling $s3$ and decoupling $s4$ of the lower arm, the F strip resonate at 3.4 GHz.

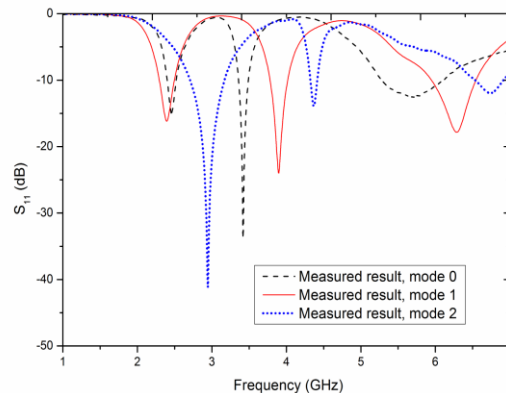

Figure 3 Measured S_{11} versus frequency for Tri-band operation modes

Coupling s_3 and s_4 to the ground plane as observed from mode 1, the effective length l_2 of the lower F strip becomes shorter, hence the frequency is shifted from 3.4 GHz in mode 0 to 3.9 GHz in mode 1. Furthermore, by coupling s_1 and s_2 in mode 2, the electrical length of l_1 becomes shorter as such the operating frequency which was 2.4 GHz in mode 0 is shifted to 2.9 GHz with S_{11} at -41.2dB, while the frequency at 3.9 GHz in mode 1, is shifted to 4.3 GHz in mode 2 with S_{11} of -13.8dB.

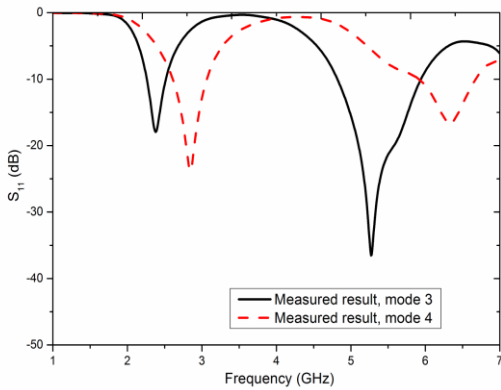

Figure 4 Measured S_{11} versus frequency for Dual-band operation modes

Furthermore, we study the effect of only the upper F strip, the return loss is presented in Figure 4. In mode 3, only switch s_1 is coupled to the ground plane, it can be observed that, the antenna operates as a dual band antenna with frequencies at 2.4 and 5.2 GHz with S_{11} at -14.8 dB and -20.1 dB respectively. We note that, 2.4 GHz frequency band is the frequency excited by the upper F strip, where the length l_1 correspond to quarter wavelength of 2.4 GHz. In addition the frequency band at 5.2 GHz is the frequency excited by the feed line with coupling effect from the F strip in the slot. Mode 4 also offer a dual band operation with frequencies at 2.8 GHz and 6.4 GHz and S_{11} at -23.8 dB and -13.2 dB. The frequency at 2.8 GHz is also due to the decrease in the effective length l_1 when switches s_1 and s_2 are coupled.

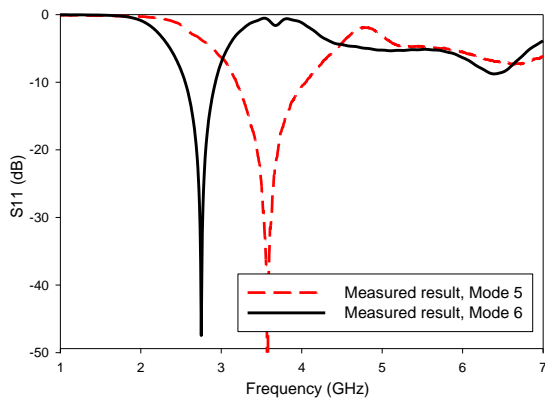
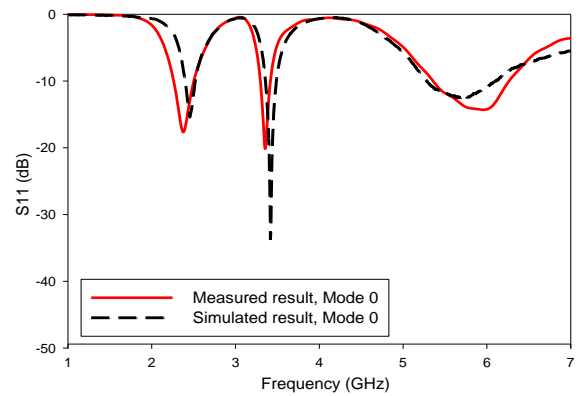
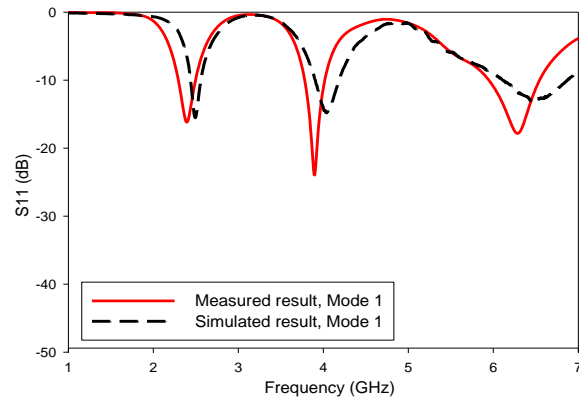

Figure 5 Measured S_{11} versus frequency for Single-band operation modes

In addition, we study the effect of the lower F strip within the slot. From Figure 5, it can be observed that single band switching can be achieved between mode 5 and mode 6. In mode 5 only the lower F strip is couple and the antenna resonate at 3.5 GHz with return loss at -50dB. Mode 6 also operates at 2.7 GHz with S_{11} at -47.9 dB. Although mode 5 is expected to operate as a dual band while mode 6 is also expected to operate in tri-band mode however, due to mutual coupling the higher order resonant frequency are poorly matched. Hence mode 5 and 6 only operates as single band.



(a)



(b)

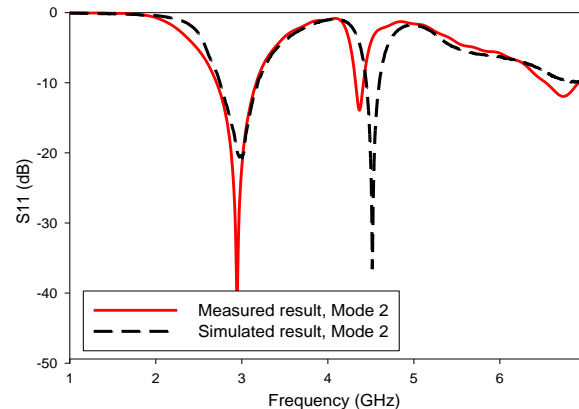

(c)

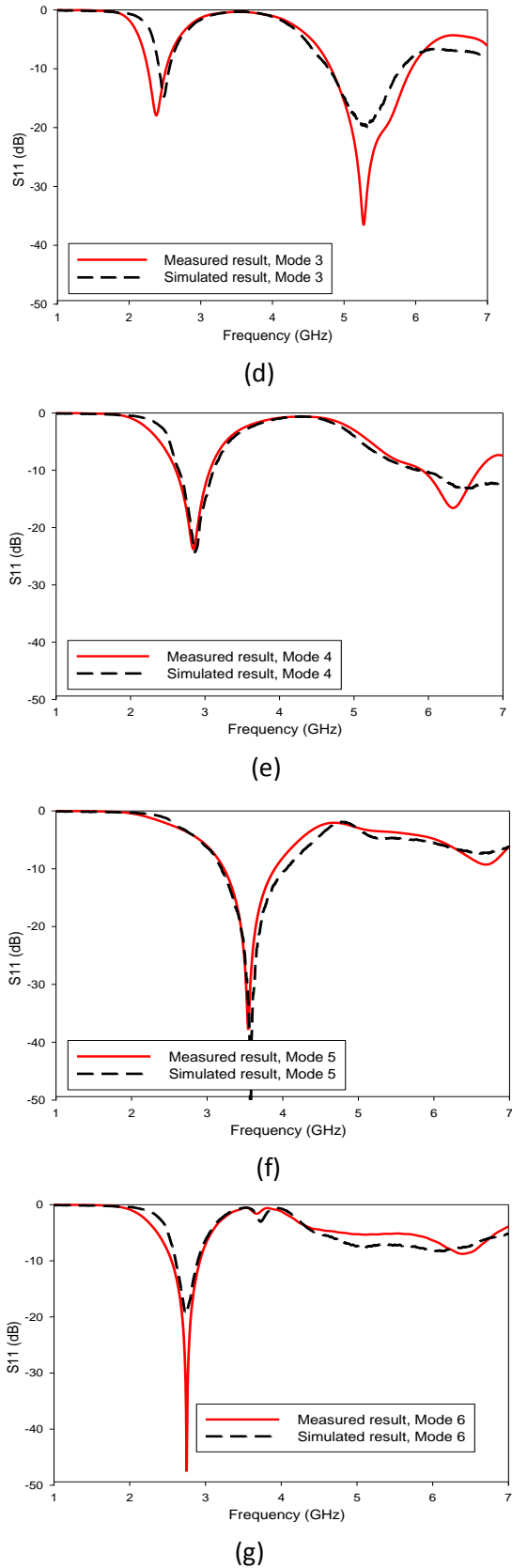

Figure 6 Comparison between measure and simulated S11 versus frequency for (a) Mode 0 (b) Mode 1 (c) Mode 2 (d) Mode 3 (e) Mode 4 (f) Mode 5 (g) Mode 6.

Figure 6 shows the comparison between the simulated and measured S11 results versus frequencies of the fabricated modes. From the Figure it can be observed that the measured results agrees with the simulated. The results also validate the achieved results of the proposed antenna. Other modes that were not fabricated can be validated also my simulations. However, they are not included in the paper as the aim of this paper is to design multiband antenna for 2.4/2.5/5.2/5.5/5.8 GHz which has been achieved from the modes already presented in this paper. To achieve other useful frequencies, other modes can be investigated.

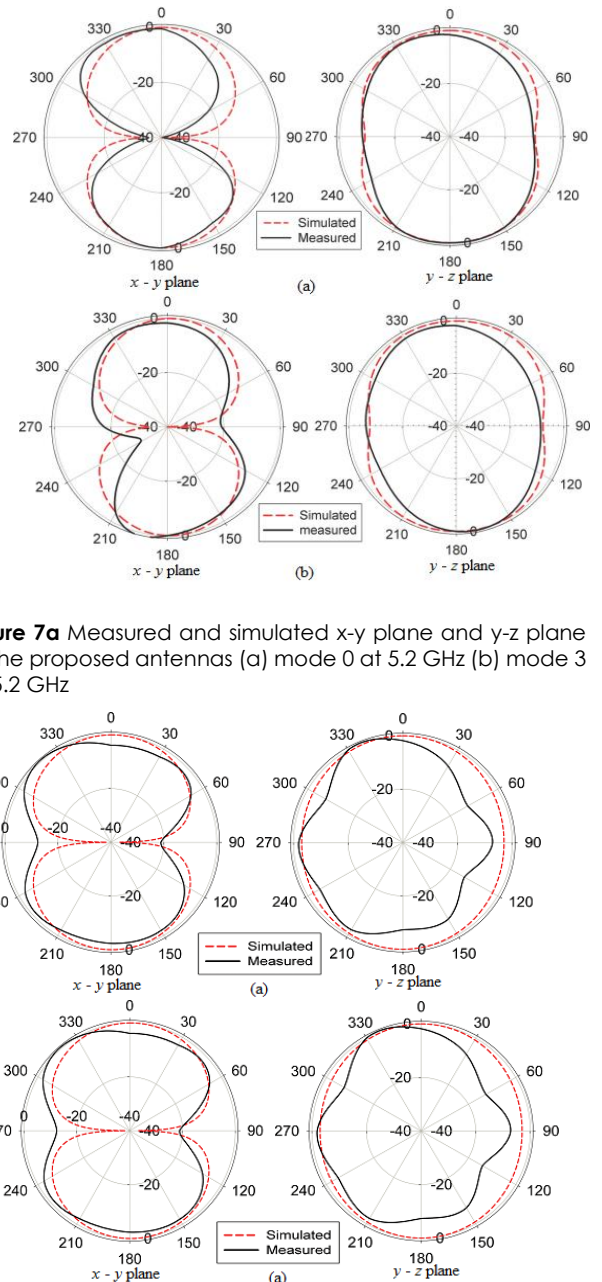

Figure 7a Measured and simulated x-y plane and y-z plane of the proposed antennas (a) mode 0 at 5.2 GHz (b) mode 3 at 5.2 GHz

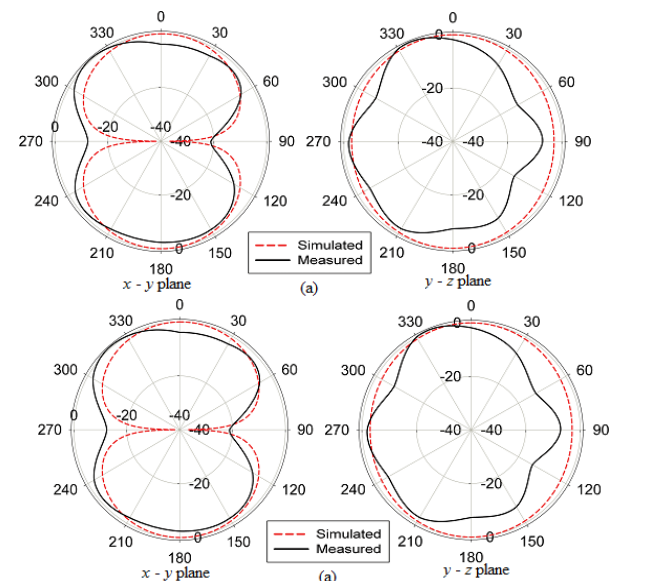

Figure 7b Measured and simulated x-y plane and y-z plane of the proposed antennas (a) mode 0 at 2.4 GHz (b) mode 1 at 2.4 GHz

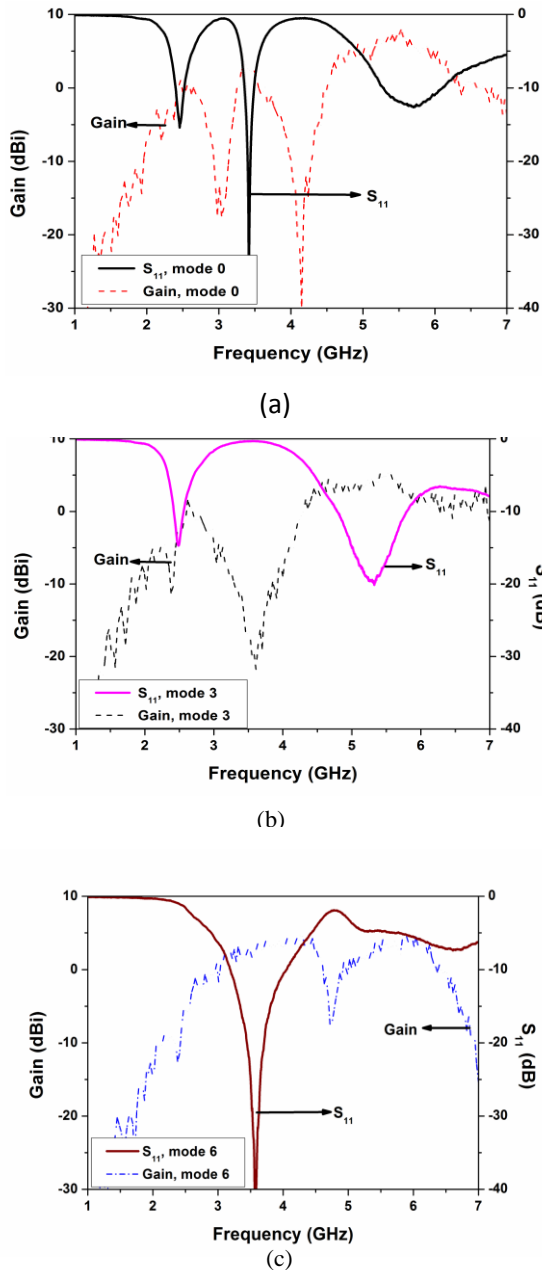

Figure 8 Measured S_{11} and gain versus frequency (a) Triband mode 0 (b) Dual-band mode 3 (c) Single band mode 5

Finally, we present the gain and radiation pattern for selected modes. Figure 7 shows the measured and simulated radiation pattern from different modes. Figure 7a shows the radiation pattern of mode 0 and mode 3 at 5.2 GHz while Figure 7b shows the radiation pattern at 2.4 GHz for mode 0 and mode 1. It can be observed that, at the same frequencies, the radiation characteristics for different modes have good and similar performance. The gains plots are presented in Figure 7, the gain obtained ranges between 2.5 to 6 dBi which makes the proposed antenna useful for omni-directional application.

4.0 CONCLUSION

A simple multiband slot antenna fed by coplanar waveguide has been designed and tested. The designed antenna configurations, are achieved by coupling or decoupling the F planar strips placed within a slotted ground. Suitable frequencies of 2.4, 5.2, and 5.8 GHz band for WLAN applications and 3.5, 5.5 GHz for WiMAX applications are achieved. The achieved bandwidth are also large enough for the bandwidth required by WLAN and WiMAX applications. The effect of the F strips placed within the slot has been investigated and the resonant frequencies have been shown to have connections with certain part of the proposed antenna. A Good agreement between simulated and measured results has been achieved. Other frequencies generated by the antenna, shows that the antenna is also potentially useful for future wireless systems such as cognitive radios.

The antenna can be further improved by using real switches to achieve the reconfigurations of the F strips instead of ideal switches.

Acknowledgement

This work was supported by Universiti Teknologi Malaysia, with grant reference number: (Q.J130000.2523.10H08).

References

- [1] Yang, S., C., Zhang, H. K., Pan, A. E., Fathy, and V. K. Nair, (2009). Frequency-reconfigurable antennas for multiradio wireless platforms. *Microwave magazine. IEEE*. 10(1): 66-83.
- [2] Chakraborty, U., A. Kundu, S. Chowdhury, and A. Bhattacharjee. 2014. *Compact Dual Band Microstrip Antenna for IEEE 802.11 a WLAN Application*.
- [3] Zhao, Q., Gong, S. X., Jiang, W., Yang, B., and Xie, J. 2010. Compact wide-slot tri-band antenna for WLAN/WiMAX applications. *Progress In Electromagnetics Research Letters*. 18: 9-18.
- [4] H Sun, X. L., Zhang, J., Cheung, S. W., and Yuk, T. I. 2012. A triple-band monopole antenna for WLAN and WiMAX applications. In *Antennas and Propagation Society International Symposium (APSURSI), 2012 IEEE*. 1-2.
- [5] Majid, H. A., Rahim, M. K. A., Hamid, M. R., and Ismail, M. F. 2012. A compact frequency-reconfigurable narrowband microstrip slot antenna. *Antennas and Wireless Propagation Letters, IEEE*. 11: 616-619.
- [6] Jung, Y. B. 2010. Dual-band reconfigurable antenna for base-station applications. *Electronics Letters*. 46(3): 195-196.
- [7] Moeikham, P., and Akkaraekthalin, P. 2013. Printed slot antenna for WLAN/WiMAX and UWB applications. In *Antennas & Propagation (ISAP), 2013 Proceedings of the International Symposium*. 1: 88-91. IEEE.
- [8] Pimpol, S., and Wongsan, R. 2013. CPW-fed dual wideband using stub split-ring rectangular slot antenna. In *Electrical Engineering/Electronics, Computer, Telecommunications and Information Technology (ECTI-CON), 2013 10th International Conference*. 1-4. IEEE.
- [9] Yahia, A. H., Shaalan, N. M., and Gad, N. H. 2012, April. B13. CPW-fed square-spiral slot antenna design for wideband applications. In *Radio Science Conference (NRSC), 2012 29th National*. 103-110. IEEE.

- [10] Chen, Shih-Wei, Deng-Yin Wang, and Wen-Hua Tu, 2013. *Dual-Band/Tri-Band/Broadband CPW-Fed Stepped-Impedance Slot Dipole Antennas*. 62: 485-490.
- [11] Idris, I. H., Hamid, M. R., Jamaluddin, M. H., Rahim, M. K. A., Kassim, N. M., Majid, H. A., and Mohamad, H. 2014. *Multi-narrowband-reconfigurable slot dipole antenna*. *Microwave and Optical Technology Letters*. 56(3): 735-740.