

IMPLEMENTING ACTIVE FORCE CONTROL TO REDUCE VIBRATION OF A SHORT LENGTH DRIVE SHAFT

Mustafa Mohebbi^a, Mahdi Hashemi^a, Musa Mailah^{b*}

^aDepartment of Electrical Eng., Faculty of Engineering, Islamic Azad University of Bojnourd, 97796 Bojnourd, Iran

^bDepartment of Applied Mechanics & Design, Faculty of Mechanical Engineering, Universiti Teknologi Malaysia, 81310 UTM Johor Bahru, Johor, Malaysia

Article history

Received

2 March 2016

Received in revised form

18 July 2016

Accepted

15 September 2016

*Corresponding author
musa@fkm.utm.my

Abstract

Vibration is a physical phenomenon involving repeated oscillatory movements or fluctuations at certain frequency and typically undesirable in many applications since it may cause undue failure or damage to the system. In this paper, the vibration of a three degree-of-freedom (DOF) model representing a short length drive shaft has been effectively and robustly suppressed through the implementation of a novel Active Force Control (AFC) used in conjunction with a classic proportional-integral-derivative (PID) controller. The shaft vibration caused by its support and constraint during its operation was simulated using MATLAB and Simulink considering a number of operating and loading conditions. The results proved that when a pure PID controller was implemented, the vibration is indeed reduced but at the expense of longer execution time and producing noticeable frequency oscillation with slight offset. On the other hand, when the AFC loop was engaged by adding it directly in series with the PID controller (PID+AFC) to produce a 2 DOF controller without any need to further tune the PID controller gains, the vibration is significantly reduced with the amplitude hovering a zero datum without any offset and yielding an extremely low frequency trending.

Keywords: Short length drive shaft, vibration, PID controller, active force control

Abstrak

Getaran merupakan satu fenomena fizik melibatkan gerakan ayunan berulang pada frekuensi tertentu dan selalunya tidak dingini dalam banyak aplikasi disebabkan ia boleh mengakibatkan kegagalan atau keroskan pada sebuah sistem. Dalam kajian ini, getaran bagi suatu model tiga darjah kebebasan (DOF) aci pemacu berukuran pendek telah dapat dikurangkan dengan berkesan dan ampuh menggunakan kawalan daya aktif (AFC) bersama kawalan klasik berkadaran-kamiran-terbitan (PID). Getaran aci yang berpunca daripada penyokong dan kekangan semasa ia beroperasi telah dilakukan kerja penyelidikan menggunakan MATLAB dan Simulink dengan mengambil kira beberapa keadaan operasi dan bebanan. Hasil keputusan menunjukkan bahawa apabila hanya pengawal PID digunakan, getaran sememangnya dapat dikurangkan tetapi ia mengambil masa yang agak lama dan pada frekuensi ayunan yang tinggi dengan sedikit ofset. Walau bagaimanapun, setelah gelung AFC diaktifkan dengan hanya menambah kepada pengawal PID sediaada secara bersiri (PID+AFC) untuk menjadikan pengawal 2 DOF, tanpa memerlukan penalaan gandaan PID, getaran dapat dikurangkan dengan ketara dengan amplitudnya menghampiri datum sifar tanpa sebarang ofset dan menghasilkan satu frekuensi ayunan yang amat rendah.

Kata kunci: Aci pemacu pendek, getaran, pengawal PID, kawalan daya aktif

© 2016 Penerbit UTM Press. All rights reserved

1.0 INTRODUCTION

Rotating shafts are used to transmit torque along one side to the other. During the operation, unwanted vibration can occur in rotating shafts, in which they

are mainly due to unbalancing and lack of good support or constraint and unsuitable tolerances. There are three main types of unbalancing in rotational shafts or rotors [1-4] and they are, namely, static, couple and dynamic unbalance. The first

occurs where the mass axis is shifted parallel to the shaft axis, and in order to correct the unbalancing, only one axial plane should be taken into consideration. The second type of unbalancing takes place with the intersection of the mass axis and the running axis. The couple unbalance type often exists in two planes. The third type usually happens where there is no coincidence between the rotational axis and the mass axis. This type of unbalancing is a mixture of couple and static unbalances, and it usually gets corrected in two planes.

Usual methods that are implemented to improve and correct the effects of unbalancing are to remove, add, and to move some material (mass) of the rotatory shafts [4]. In order to determine the best method, it is important to analyze the physical properties of the device that is rotating. Another main reason for a drive shaft to suffer from vibration, is when the shaft is operating with support and constraint that are not fixed with suitable tolerances. A few samples of these conditions can be found in typical vibration text books [5]. In some machines and mechanisms, the support and constraint that are holding the shaft can get worn out and thus lose their suitable tolerance.

In this article, to reduce the noise and vibration that occur in a short length of rotating shaft, a closed loop control system is employed, known as active force control (AFC) along with a PID control element. One of the biggest benefits of the AFC method is its capability to reject the disturbances that are forcibly applied to the system through suitable handling of the designated parameters. Furthermore, the method requires far less computational task and has been well reported that it is readily applied in real-time [6]. The method of AFC was first presented by Hewitt and Burdett [7], and it turned out to be very robust and efficient in controlling a robot arm. Later on, other researchers successfully applied this method to a robot arm and structure incorporating artificial intelligence (AI) techniques [6, 8, 9] and employing various active elements (actuators) such as pneumatic artificial muscle actuator (PAM) [10], voice coil actuator (VCA) [11] and piezoelectric actuator [12]. The AFC technique is also very much capable and successful in reducing friction induced vibration (FIV) [12-15] applied to various brake models in which the FIV is caused by the effects of negative damping and modal coupling. The methodology of AFC was also used and implemented for micro robots, in which the results were very satisfying [16-17]. The application of AFC to reduce vibration in various mechanical structures can be found in [18-21].

2.0 DYNAMIC MODEL OF THE SHORT LENGTH DRIVE SHAFT

A 3 DOF dynamic model of a short length of drive shaft is shown in Figure 1. The fact that the length of

the shaft is short and the cross section area of the shaft is usually 10% of its length, for the purpose of vibration analysis, the shaft is considered as a lumped parameter instead of a continuous element. Also, since the material considered for this shaft has a high modulus of elasticity, continuous element analysis is not necessary. In this model, the driving shaft is caused to vibrate due to lack of suitable constraint and support or tolerances with the geometric shape and length of the shaft is assumed to be uniform, i.e., a cylindrical bar. As shown in Figure 1, there are two directions of movements, one in the x and y plane and the other, a rotational direction θ which is the rotation around the cross sectional axis of the shaft.

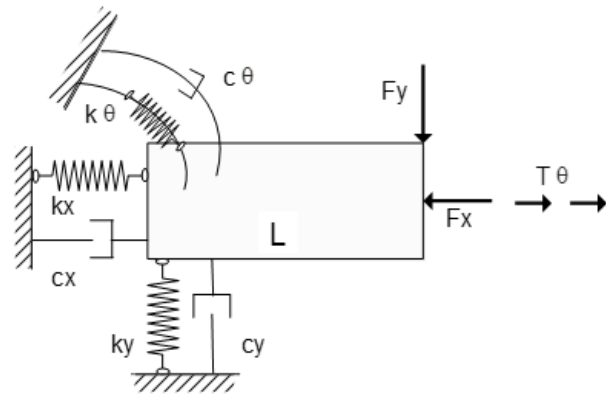

Figure 1 A 3 DOF dynamic model of a short length drive shaft

The designated specifications of this short length shaft are as follows:

Length, $L = 0.3$ m
 Diameter of the circular bar, $D = 0.03$ m
 Modulus of elasticity, $E = 186$ GPa
 Shear modulus of elasticity, $G = 72$ GPa
 Mass, $m = 1.7$ kg

The dynamic equation of the above drive shaft model is written as follows:

$$\begin{cases} m\ddot{x} + c_x\dot{x} + k_x x = F_x \\ m\ddot{y} + c_y\dot{y} + k_y y = F_y \\ J\ddot{\theta} + c_\theta\dot{\theta} + k_\theta\theta = T_\theta \end{cases} \quad (1)$$

where:

m : the mass
 J : is the mass moment of inertia
 x and y : directions of movement in plane
 θ : angular movement of the cross section
 c : damping coefficient
 k : stiffness constant
 F : applied force
 T : applied torque

After obtaining the dynamic model and its equation of motion, the behavior of the model was simulated and studied using MATLAB and Simulink software. Due to the fact that a non-energy dissipating vibration of this shaft was required (for severe vibration), all the damping coefficients were deemed negligible. The values of the stiffness constants and external forces are as follows:

- k_x : 1000 kN/m
- k_y : 400 kN/m
- k_θ : 5.71 kNm/rad
- F_x : 1 kN
- F_y : 0.60 kN
- T_θ : 0.10 kNm

Figure 2 shows the Simulink block diagram of the 3 DOF model of the short length drive shaft, also known as the passive system.

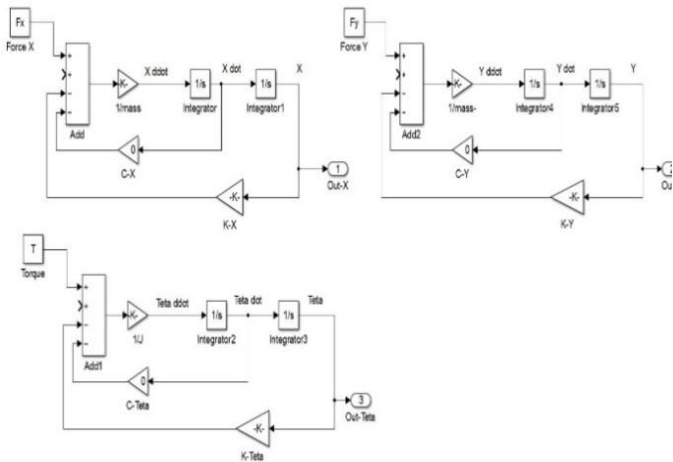

Figure 2 Simulink block diagram of the 3 DOF model of the short length drive shaft

The simulation period was set to be 5 minutes (300 s) and the type of solver chosen for this study was *Bogacki-Shampine* (*ode3* in MATLAB/Simulink) with a fixed step time sampling. Figures 3(a) and (b) show the results of this simulation in time and frequency domains, respectively for the horizontal x direction and axial loading. As can be seen, the horizontal direction of the vibration has an amplitude of 0.002 m (2 mm) and a frequency of 122 Hz.

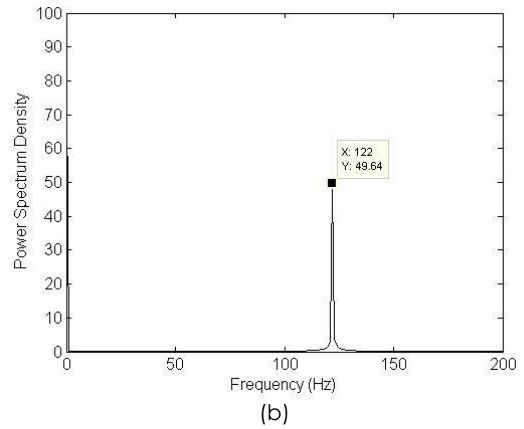
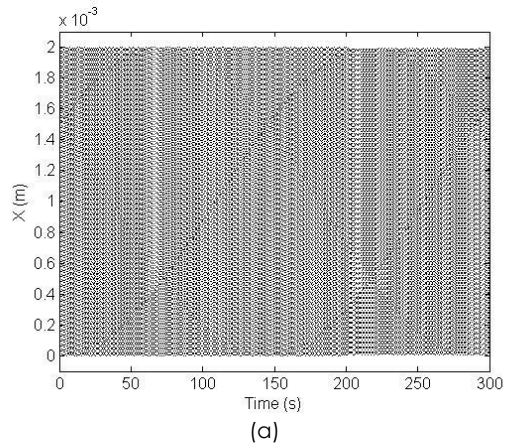
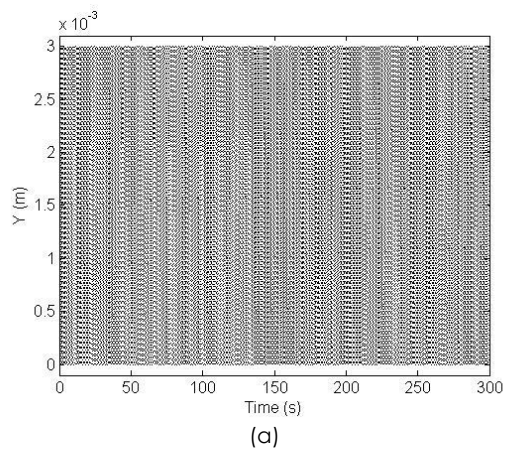

Figure 3 Vibration results in the horizontal (x) direction of the passive system in (a) time and (b) frequency domains

Figures 4 (a) and (b) show the obtained results of the passive system simulation in time and frequency domains, respectively for the vertical y direction and normal loading. It is obvious that the vibration has an amplitude of 0.003 m (3 mm) and a frequency of 77 Hz.



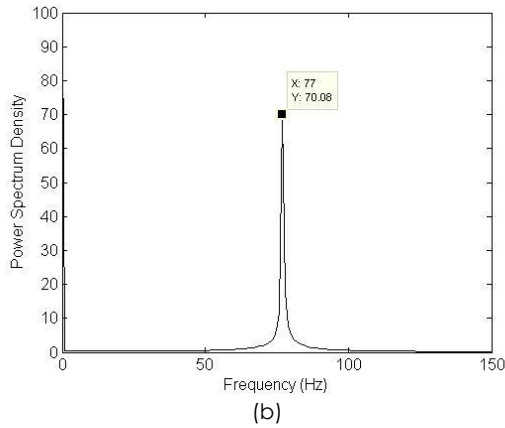

Figure 4 Vibration results in the vertical (y) direction of the passive system in (a) time and (b) frequency domains

Figures 5(a) and (b) show results of the passive system simulation in time and frequency domains, respectively for the angular θ cross sectional direction and torsional loading. It can be seen that the angular vibration has an amplitude of 0.035 rad (2 deg) with a frequency of 850 Hz.

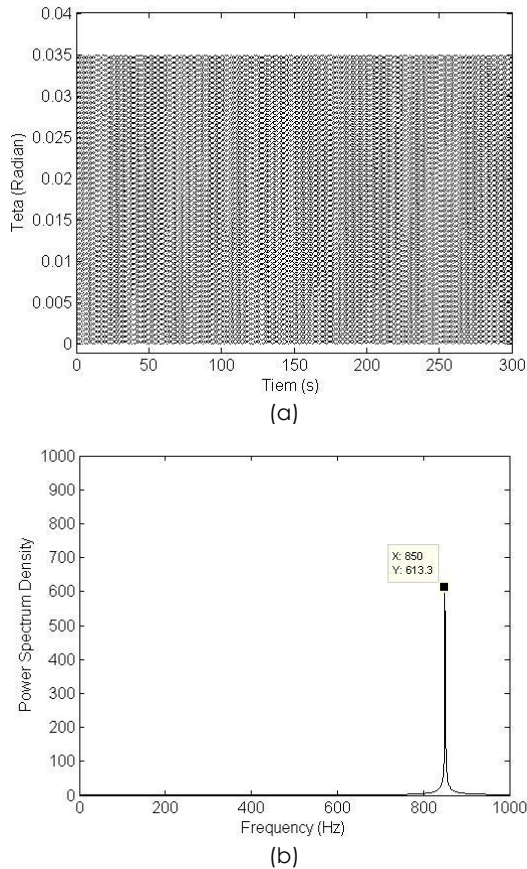

Figure 5 Vibration results in the angular (θ) direction of the passive system in (a) time and (b) frequency domains

3.0 CONTROL STRATEGY

After obtaining the 3 DOF model of the passive system and studying its behavior, the next step is to control and suppress the vibration that is produced in all directions. A good control strategy should be designed and implemented.

Thus, a strong and robust control strategy is presented, using an AFC scheme along with a conventional PID controller. A typical PID controller is of the following form:

$$G_c(s) = (K_P + K_I/s + K_Ds)e(s) \tag{2}$$

where K_P , K_I , and K_D are the proportional, integral and derivative gains, respectively, $e(s)$ is the trajectory error and $G_c(s)$ is the controller transfer function.

To tune the PID controller, firstly the Ziegler-Nichol method was employed to produce the initial values for the PID controller gains. Later on, to achieve good performance, more experimentations were carried out to determine a good combination of the gains. After tuning the PID controller, the AFC loop was applied to the control system in order to increase the efficiency and the robustness of the vibration attenuation process. The AFC scheme applied to the passive system is presented in Figure 6.

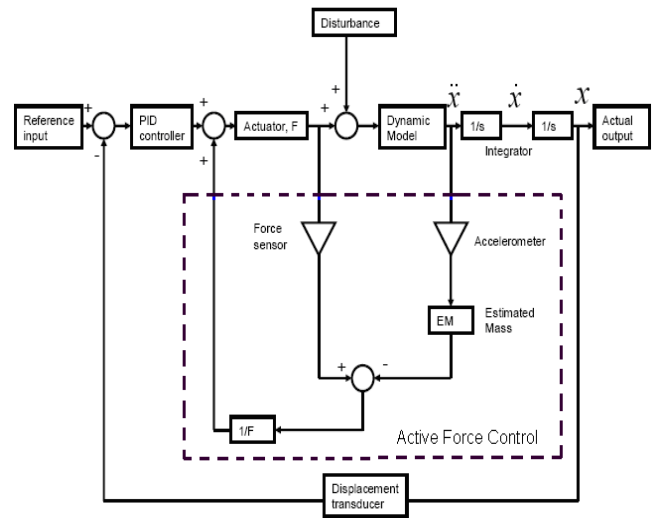

Figure 6 A schematic diagram of the AFC strategy

As previously mentioned, the AFC loop is proven to be very effective in providing the estimated actuated force through computing the proper estimated mass value [6, 7]. The main AFC equation with reference to Figure 6 contained in the dashed box is related to the evaluation of the estimated disturbance force, F_d as follows:

$$F_d = F - EM \ddot{x} \tag{2}$$

where F is the measured actuating force, EM is the estimated mass and \ddot{x} is the measured acceleration. The obtained parameter F_a is later fed back through an inverse transfer function of the actuator and then summed up with the signal of the PID control. The hypothetical analysis and the stability of the AFC method has been appropriately and rigorously described in [22].

4.0 SIMULATION OF THE CONTROL STRATEGY

The same conditions and solver that were used in section 2 were implemented here through MATLAB/Simulink computing platform. At first, for every DOF in the passive model of the drive shaft, a PID controller with a linear actuator was considered. Note that it comprises a 3 DOF system, implying that it requires three separate controllers to control each DOF. Then after tuning the PID controller and obtaining a suitable value for the linear actuator coefficient, the performance of the driving shaft system for vibration suppression was tested. Afterwards, the AFC loop was added (cascaded in series) to each of the PID controller, and the values of the estimated mass (EM) for each AFC loop was obtained by crude approximation method. The PID controller gains and the estimated mass/inertia that were assigned to each DOF are given in Table 1. The values of I and gains in θ direction are very small because the moment of inertia of the shaft is small and so is the applied torque.

Table 1 Parameters used in the simulation

Direction	EM/I for AFC	Actuator coefficient for AFC	PID controller gains		
			K_p	K_i	K_d
x	3.0 kg	0.20	0.75	0.50	0.11
y	2.7 kg	0.20	0.50	0.30	0.075
θ	4 e-5 kgm ²	0.02	4 e-4	3.5 e-4	1.2 e-4

It should also be noted that the linear actuator coefficients were assumed and estimated based on the size of the physical motor obtained from a datasheet. As previously mentioned, the Ziegler-Nichol method for tuning the PID controller gains was used to obtain the initial values, and then further tuned experimentally (via numerical simulation) in order to come up with a suitable vibration reduction of the drive shaft. Figure 7 shows the Simulink block diagram of the passive system when three PID controllers and three corresponding AFC loops were directly added in series. In other word, for each DOF, an independent PID controller and AFC loop is considered.

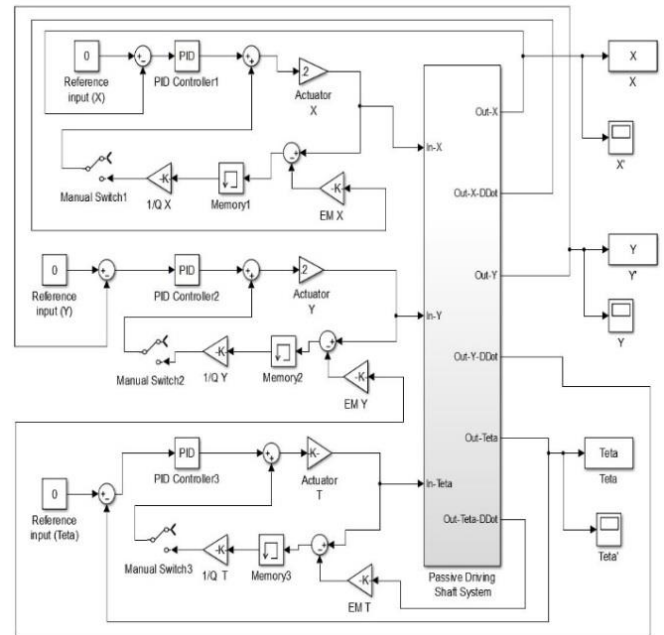

Figure 7 Simulink block diagram of the PID controllers and AFC loops for the 3 DOF passive system

5.0 RESULTS AND DISCUSSION

After obtaining the Simulink block diagram and tuning the PID and AFC parameters, the simulation was executed by first considering the PID controllers only, and then the PID plus AFC control loops. Figures 8(a) through (c) show the result of the two simulations (PID and PID+AFC) for the horizontal x direction in time and frequency domains. It can be noticed that when the control system is operating with only a PID controller, the vibration is observed to show an upward offset but slow gradual decreasing trend with increasing frequency. On the other hand, when the AFC loop is engaged along with the PID controller, the frequency of oscillation is greatly reduced to less than 0.1 Hz, and the amplitude significantly shows a decreasing trend with much less magnitude. Note that the characteristics of the curve, though seemingly oscillatory, are for amplitudes within 20×10^{-4} m region which is relatively very small in comparison to the dimension of the shaft.

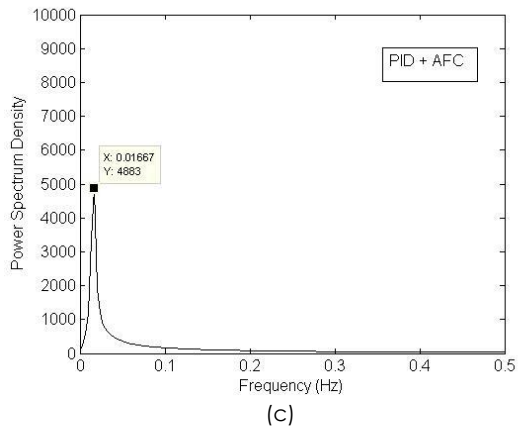
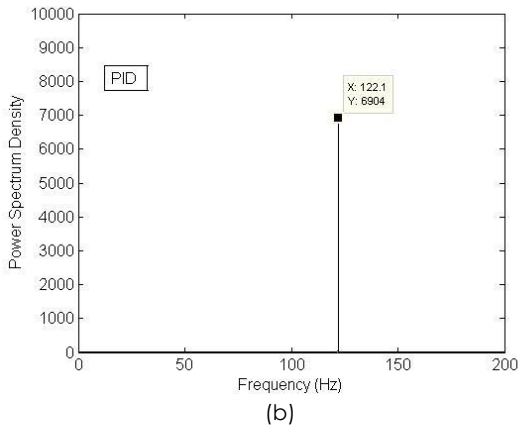
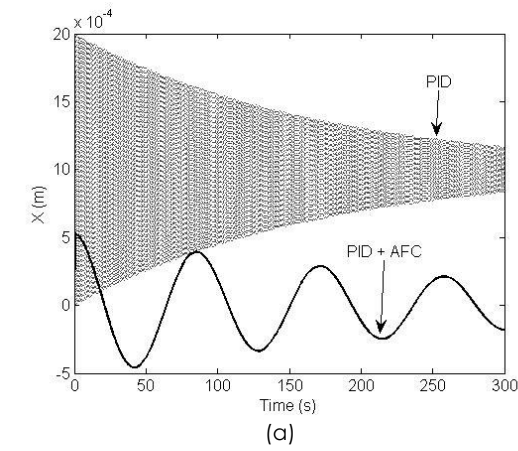

Figure 8 Comparison of results in reducing the vibration in the horizontal (x) direction by (a) both PID and PID+AFC in time history (b) PID and (c) PID+AFC in frequency domain

Figures 9 and 10 show the results for the vertical y and θ directions, respectively. Again, similar trend was observed, implying that the vibration is also effectively suppressed at a much faster rate and bigger magnitude (lower frequency) when the AFC loop was engaged with the PID controller. The amplitude is seen largely reduced as it is hovering about the zero datum without any undesirable offset.

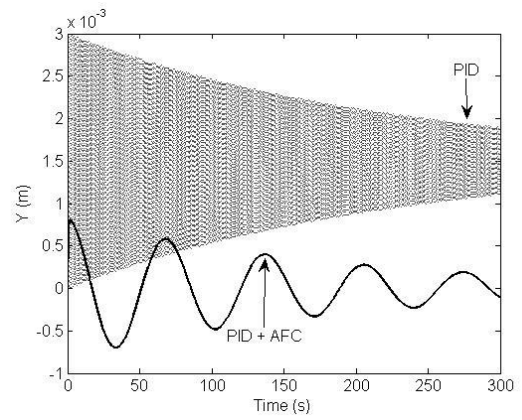

Figure 9 Comparison of results in reducing vibration in the vertical (y) direction by PID and PID+AFC

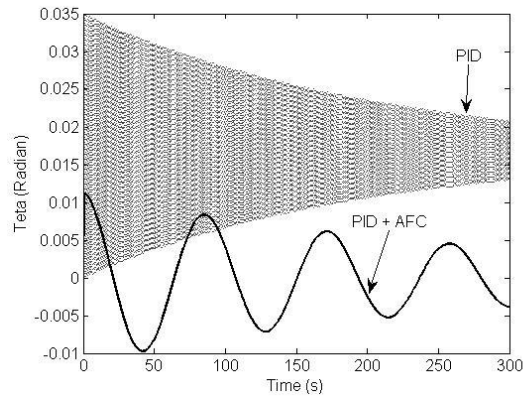

Figure 10 Comparison of results in reducing the vibration in the angular (θ) direction by PID and PID+AFC

In order to evaluate the robustness of the control system in reducing the unwanted vibration in the drive shaft, another set of simulation with the same procedure was performed. But this time around, the external load for each direction (DOF) was increased to more than 50%. Figure 11 shows the result of reducing the vibration in the horizontal x direction when the horizontal external load is increased from 1 to 1.5 kN. It can be noticed that the PID system is indeed attenuating the vibration but consumes more time with high frequency fluctuation and that the amplitude of the vibration is relatively high especially within first two minutes. On the other hand, for PID+AFC scheme, the vibration is very much suppressed in magnitude and it produces very low frequency oscillation. For the vertical y direction, the normal load was increased from 0.60 to 0.90 kN, and for the θ direction, the external torque was increased from 100 to 150 Nm.

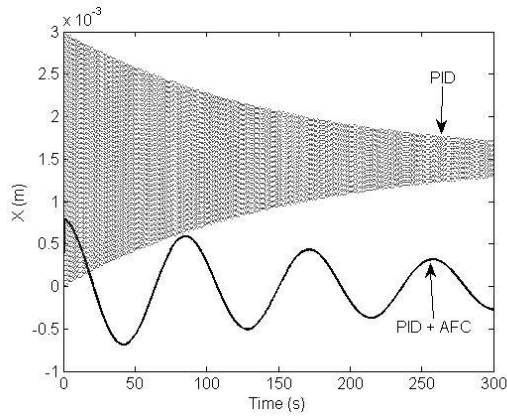

Figure 11 Comparison of results in reducing the vibration in the horizontal (x) direction by PID and PID+AFC with external load increased to 1.5 kN

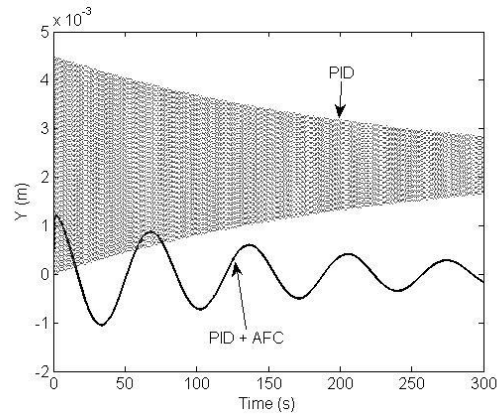

Figure 12 Comparison of results in reducing the vibration for the vertical (y) direction by PID and PID+AFC, with external normal load increased to 0.9 kN

Figures 12 and 13 show the results when the external normal load and torque, respectively are increased. Again, it can be seen that the PID+AFC controller manages to minimize the vibration significantly, in terms of magnitude and frequency reduction compared to the PID controller only counterpart. From the results shown in Figures 8 to 13, it is very obvious that undesirable offsets, mainly due to static unbalancing, were produced by the PID controller for the rotating short drive shaft undergoing the given loading and operating conditions; i.e., the shaft is forcibly displaced for about 1.5 to 2 mm in translation and 0.015 to 0.025 rad in rotation and that it vibrates at relatively high frequency though towards the end, there is attenuation in vibration magnitude. It therefore signifies that the PID controller performance is sensitive, easily affected adversely and hence not robust against the disturbances. This also shows that the fixed PID controller gains could not facilitate or adapt to the changes in the disturbances. However, the performance was greatly enhanced with the onset of an AFC-based scheme cascaded in series with the conventional PID control scheme (same controller gains) whereby it totally eliminates the offsets and reduces the vibration magnitudes and their frequencies.

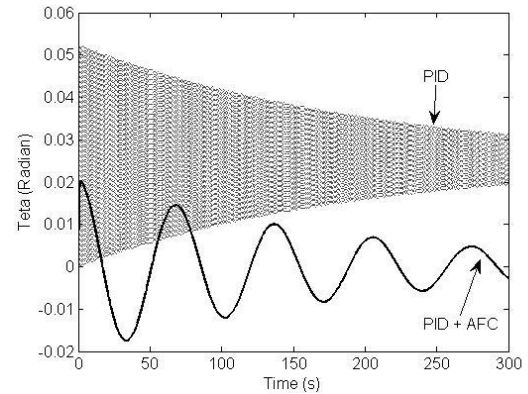

Figure 13 Comparison of results in reducing the vibration for the angular (θ) direction by PID and PID+AFC, with external torque increased to 150 Nm

Table 2 Summary of the vibration results (normal loading) obtained for both with and without controller at 150 s of simulation period

Controller (direction)	Amplitude	Frequency (Hz)
Without (x)	2.0 mm	122
Without (y)	3.0 mm	77
Without (θ)	0.035 rad	850
PID (x)	1.5 mm	122
PID (y)	2.2 mm	77
PID (θ)	0.025 rad	850
PID+AFC (x)	0.2 mm	below 0.5
PID+AFC (y)	0.3 mm	below 0.5
PID+AFC (θ)	0.004 rad	below 0.5

6.0 CONCLUSION

A 3 DOF model of a short length drive shaft was developed and numerically experimented. The behavior of the model was tested and simulated considering the PID and AFC-based schemes and introduced operating and loading conditions. It was noticed that the PID controller alone was able to reduce the vibration, but the process was a bit time consuming and resulted in noticeable frequency oscillation with an upward offset due to the effect of disturbances. On the other hand, when the AFC loop was added to the PID controller (PID+AFC), the vibration was significantly reduced at a much faster rate and the amplitude was heading towards zero, without any offset. In addition, the frequency of oscillation was greatly decreased to indicate that the vibration has been effectively suppressed and the offset produced by the PID scheme totally eliminated. The robustness of the proposed control strategy was also verified through analysing the results obtained when the shaft is subject to an increase in the external loads of about 50% and yet the PID+AFC control scheme was able to reduce the vibration (with respect to its amplitude and frequency) very efficiently.

References

- [1] Berry, J. E. 1997. Analysis I: How to Implement An Effective Condition Monitoring Program using Vibration Analysis. Technical Associates of Charlotte, P.C. 6-15.
- [2] Mass unbalance and vibration at 1X running speed. 2015. Retrieved 10 May 2015. <http://centrifugalpump.org/unbalance.html>.
- [3] Michael, L. H. 2007. *Detecting & Correcting Unbalance in Tool holders for High Speed Machining*. American Hoffman Cooperation.
- [4] Universal Balancing. 2015. Retrieved 1 April 2015. <http://www.universal-balancing.com/en/balancing-information/what-is-balancing>.
- [5] Rao, S. S. 2011. *Mechanical Vibrations*. 5th edition. Prentice Hall.
- [6] Mailah, M. 1998. Intelligent Active Force Control of a Rigid Robot Arm using Neural Network and Iterative Learning Algorithms. Ph.D Thesis. University of Dundee, UK.
- [7] Hewit, J. R. and J. S. Burdess. 1981. Fast Dynamic Decoupled Control for Robotics using Active Force Control. *Mechanism and Machine Theory*. 16(5): 535-542.
- [8] Tahmasebi, M., R. Abd Rahman, M. Mailah, and M. Gohari. 2013. Roll Movement Control of a Spray Boom Structure using Active Force Control with Artificial Neural Network Strategy. *Journal of Low Frequency Noise Vibration and Active Control*. 32(3): 189-201.
- [9] Noshadi, A. and M. Mailah. 2011. Fuzzy-based Active Force with Computed Torque Control of A 3-RRR Parallel Manipulator. *International Review on Modelling and Simulation*. 4(5): 2666-2676.
- [10] Jahanabadi, H., M. Mailah, M. Z. M. Zain, and H. H. Mun. 2011. Active Force with Fuzzy Logic Control of a Two-Link Arm Driven by Pneumatic Artificial Muscles. *Journal of Bionic Engineering*. 8(4): 474-484.
- [11] Azizan A., M. Z. M. Zain, M. Mailah, and M. Hussein. 2013. Hybrid Learning Control for Improving Suppression of Hand Tremor. *Proceedings of the Institution of Mechanical Engineers, Part H: Journal of Engineering in Medicine*. 227(11): 1171-1180.
- [12] Hashemi-Dehkordi, S. M., A. R. Abu Bakar, and M. Mailah. 2012. Reducing Friction-induced Vibration Using Intelligent Active Force Control (AFC) With Piezoelectric Actuators. *SADHANA - Academy Proceedings in Engineering Sciences*. 37(6): 637-655.
- [13] Hashemi-Dehkordi, S. M., A. R. Abu Bakar, and M. Mailah. 2014. Stability Analysis of a Linear Friction-Induced Vibration Model and Its Prevention using Active Force Control. *Advances in Mechanical Engineering*. Article ID: 251594, 13 pages. <http://dx.doi.org/10.1155/2014/251594>.
- [14] Hashemi-Dehkordi, S. M., M. Mailah, and A. R. Abu Bakar. 2009. Implementation of Active Force Control to Disk Brake Noise-Free Performance. *International Review of Mechanical Engineering*. 3(4): 481-488.
- [15] Hashemi-Dehkordi, S. M., M. Mailah, and A. R. Abu Bakar. 2009. Intelligent Active Force Control with Piezoelectric Actuators to Reduce Friction Induced Vibration Due to Negative Damping. *International Review of Electrical Engineering*. 4(6): 1294-1305.
- [16] Sabzehmeidani, Y., M. Mailah, and M. Hussein. 2011. Modelling and Control of a Worm-Like Micro Robot with Active Force Control Capability. *International Journal of Modelling, Identification and Control*. 13(4): 301-309.
- [17] Sabzehmeidani, Y., M. Mailah and M. Hussein. 2012. Piezoelectric Actuated In-pipe Microrobot with P-type Iterative Learning Active Force Control. *Latest Advances in Systems Science and Computational Intelligence*. 1: 192-197.
- [18] Mohamed, M., A. H. Muhaimin, and M. Mailah. 2006. Vibration Control of A Mechanical Suspension System Using Active Force Control. *Proceedings of Regional Conference on Vehicle Engineering Technology, RiVET 2006*. Kuala Lumpur, Malaysia.
- [19] Tavakolpour, A. R. and M. Mailah. 2012. Control of Resonance Phenomenon in Flexible Structures via Active Support. *Journal of Sound and Vibration*. 331(15): 3451-3465.
- [20] Tavakolpour, A. R., M. Mailah, and I. Z. M. Darus. 2011. Modelling and Simulation of a Novel Active Vibration Control for Flexible Structures. *WSEAS Transactions on Systems and Control*. 6(5): 184-195.
- [21] Darus, I. Z. M., T. A. Z. Rahman, and M. Mailah. 2011. Experimental Evaluation of Active Force Vibration Control of A Flexible Structure using Smart Material. *International Review of Mechanical Engineering*. 5(6): 1088-1094.
- [22] Burdess, J. S. and J. R. Hewit. 1986. An Active Method for the Control of Mechanical Systems in the Presence of Unmeasurable Forcing. *Mechanism and Machine Theory*. 21(5): 393-400.