

MULTI-STATE ANALYSIS OF PROCESS STATUS USING MULTILEVEL FLOW MODELLING AND BAYESIAN NETWORK

Mohamed A. R. Khalil^a, Arshad Ahmad^{a,b*}, Tuan Amran Tuan Abdullah^{a,b}, Ali Al-Shatri^a, Ali Al-Shanini^c

^aCenter of Hydrogen Energy, Institute of Future Energy, Universiti Teknologi Malaysia, 81310 UTM Johor Bahru, Malaysia

^bDepartment of Chemical Engineering, Faculty of Chemical & Energy Engineering, Universiti Teknologi Malaysia, 81310 UTM Johor Bahru, Malaysia

^cDepartment of Chemical Engineering, Hadhramout University, Mukalla, Yemen

Article history

Received

19 May 2015

Received in revised form

24 March 2016

Accepted

1 May 2016

*Corresponding author:

arshad@utm.my

Graphical abstract

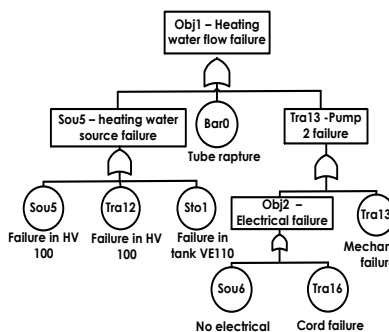

Abstract

Multilevel Flow Modeling (MFM) model maps functionality of components in a system through logical interconnections and is effective in predicting success rates of tasks undertaken. However, the output of this model is binary, which is taken at its extrema, i.e., success and failure, while in reality, the operational status of plant components often spans between these end. In this paper, a multi-state model is proposed by adding probabilistic information to the modelling framework. Using a heat exchanger pilot plant as a case study, the MFM model is transformed into its fault tree [1] equivalent to incorporate failure probability information. To facilitate computations, the FT model is transformed into Bayesian Network model, and applied for fault detection and diagnosis problems. The results obtained illustrate the effectiveness and feasibility of the proposed method.

Keywords: Functional modeling, multi-state system, multilevel flow modeling, fault tree analysis, Bayesian network.

Abstrak

Model Permodelan Pelbagai Aras (MFM) memetakan fungsi-fungsi komponen-komponen dalam sistem secara logical dan ianya berkesan dalam meramal kadar kejayaan tugas yang dilaksanakan. Walau bagaimanapun, keluaran dari model ini adalah binari dengan nilai yang diambil pada titik ekstrema, iaitu sama ada berjaya atau gagal, sedangkan pada keadaan sebenar, status operasi komponen loji sering menjangkau titik-titik di antara kedua ekstrema tersebut. Dalam artikel ini, model pelbagai keadaan dicadangkan dengan menambah maklumat kebarangkalian kepada rangka kerja model. Dengan menggunakan loji perintis penukar haba sebagai kajian kes, model MFM itu ditukar menjadi model yang setara dalam format pokok gagal [1] yang menggabungkan maklumat kebarangkalian kegagalan. Untuk memudahkan pengiraan, model FT itu diubah kepada model rangkaian Bayesian, dan digunakan untuk permasalahan pengesanan dan diagnosis kerosakan. Keputusan yang diperolehi menggambarkan keberkesanan dan kesesuaian kaedah yang dicadangkan.

Kata kunci: Permodelan berasaskan berfungsi, sistem pelbagai keadaan, model aliran pelbagai aras, analisis pokok gagal, rangkaian Bayesian.

© 2016 Penerbit UTM Press. All rights reserved

1.0 INTRODUCTION

Multilevel Flow Modelling (MFM) is a functional modelling technique with high level of abstraction, and belongs to a class of artificial intelligence research called qualitative reasoning [2]. The relationship between functions and the objective or main goal of the system in MFM model is determined by cause–effect relationships, based on means–end relations to represent the process in multiple levels of functions [3]. The causal relations between the behaviour and the intention of the system components makes the MFM model suitable for system diagnosis [4], and attracts various applications. Petersen[5] used an MFM model for alarm analysis, risk monitoring systems and fault analysis, while Larsson[6] used MFM model to describe the target of the process for measurement validation, alarm analysis and fault diagnosis.

Despite these encouraging reports, the conventional MFM model is not attractive for general use in chemical processes as it only provides binary outputs at its extrema. For applications in chemical processes, models that provide multiple states are more useful compared to those that describe the system and its components as (0, 1) and ignores their intermediate states [7, 8]. This has encouraged the development of modelling frameworks such as multi–state event tree and multi–state fault tree [9–11]. The idea of using multi–state system in engineering was popularised by [12] by expressing the expected outcomes in terms of failure probabilities or frequencies. In this paper, this idea is adopted to extend the functionality of the MFM model for the purpose of fault detection and diagnosis. By converting the fault tree developed from the MFM model into Bayesian network, the desired analysis of multi–state system can be carried out using conditional probability distribution to represent the relationship between components states and system target.

2.0 THE CAUSALITY SYSTEM IN MFM

In this paper, causal dependency graphic (CDG) is used to represent the qualitative cause–consequences analysis between components in the MFM model. The states of the MFM flow functions are shown in table 1. Each function in the MFM model may only take some of these states. Besides, to guarantee success in achieving the main goal, each function must be in a normal state [13]. According to these states the CDG of system is constructed.

Table 1 The states of flow functions in MFM

Function	Possible States
Source	Normal, high volume, low volume
Sink	Normal, high volume, low volume
Transport	Normal, high flow, low flow*
Storage	Normal, high volume, low volume
Barrier	Normal, leak
Balance	Normal, fill, leak, unbalance
Objective (goal)	True, false**

*No flow state is included as low flow state. **False state of an objective function in divided to two states, false results from the high state of functions (fault -1) while the consequences of the low state of functions is (Fault - 2).

3.0 BAYESIAN NETWORK (BN)

BN is a probabilistic graphical model that is based on directed acyclic graphs (DAG) with probability annotated. A node in a BN represents a random variable, and is linked with other variables with defined probabilistic dependencies. Using BN, qualitative and quantitative representation of the relations between variables can be established using prior and conditional probabilities of variables. Updates of these probabilities can be generated and used to represent different system probabilities. The “OR” gate in fault tree model is mapped to BN, and is equivalent to a series system, while the “AND” gate is equal to parallel system. By using BN, compactness of the model can be established by factoring the joint distribution into a local, conditional distribution for each variable given its parents. If x_i denotes a value of the variable X_i and p_{ai} denotes some set of values for the parent of X_i , then $P(x_i | p_{ai})$ denotes this conditional distribution.

4.0 CASE STUDY:

As a case study, a heat exchanger pilot plant system at Universiti Teknologi Malaysia normally used for studying heat exchange mechanisms and temperature control is examined. As illustrated in Figure 1, the plant consists of a heating medium tank (VE110), product tank (VE150), two pumps (P112, P152), heat exchanger (HX120), cooler (CL140), two heaters (HE110, HE111) and valves. Water is supplied to this plant from outside sources via hand valve HV100 and HV101 to the heating medium tank VE110 and product tank VE150 respectively. Then the water in VE110 is heated to 60 °C using heaters HE110 and HE111. The heated water is then pumped by P112 and water at room temperature is pumped by P152 to the heat exchanger HX120. Cooling water enters the product tank through the cooler CL140 if the temperature is above the target value. The main goal of this process plant is to maintain water temperature in tank VE150.

4.1 Multilevel Flow Modelling (MFM) for The Heat Exchanger Pilot Plant

The heat exchanger pilot plant illustrated in Figure 1 is converted into the MFM model and is shown in Figure 2. Note that the control systems of the plant plays important role for plant operation and safety, but is not included in this study. This process has one goal (main goal) (Go0), which is to maintain water temperature in tank VE150, and five objectives (sub - goals) for more details (Khalil et al., 2016). In this plant, heat exchanger

is the core of the system. It has two purposes, the main function is to transfer energy from the hot water to the cold water, and a secondary purpose to prevent mixing between hot and cold water via tube wall that represents in the model by barrier (Bar0). The heat exchange mechanism is represented by the balance function in the MFM model, Bal3 and Bal6 for cooling and heating water respectively for mass flow, and by Bal10 and Bal12 for energy flow structure (EFS0).

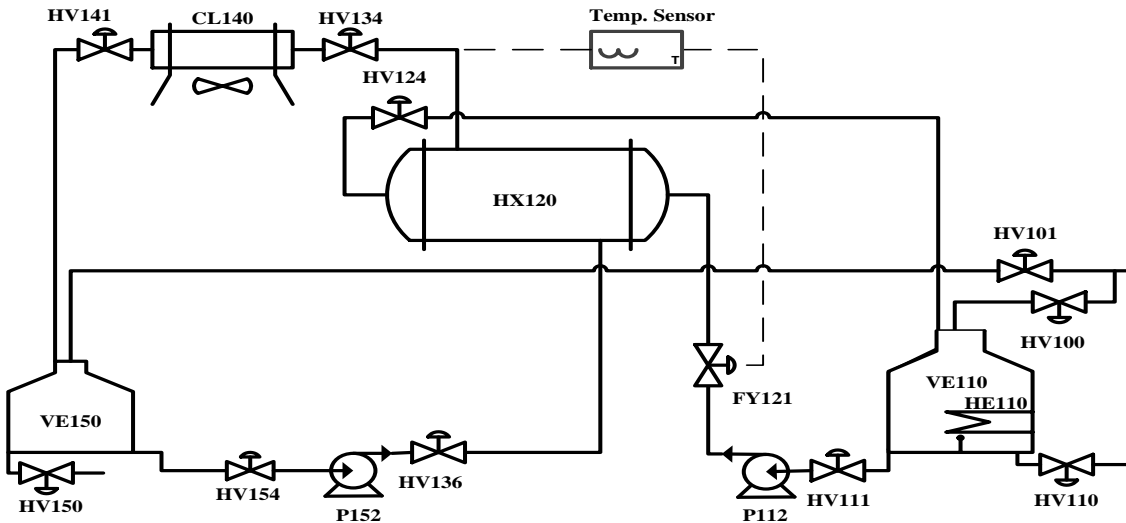

Figure 1 The heat exchanger pilot plant [14]

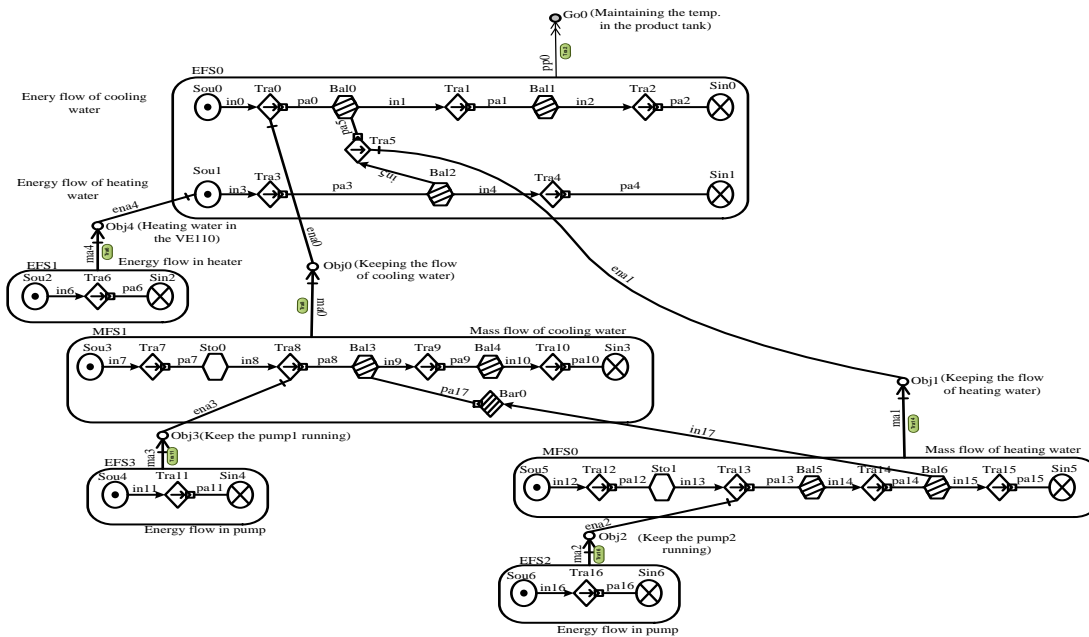

Figure 2 The MFM of the heat exchanger pilot plant [14]

4.2 Fault Tree of MFM

Figure 3 shows the fault tree model that is mapped from MFM model to incorporate probabilistic information into the modelling framework. The FT model represents the relationship between events of

the heat exchanger pilot plant, with the top event TE assumed to occur when a fault is occurring in only one component at any time. Note that in this analysis, the prior probability distributions of basic components are considered independent.

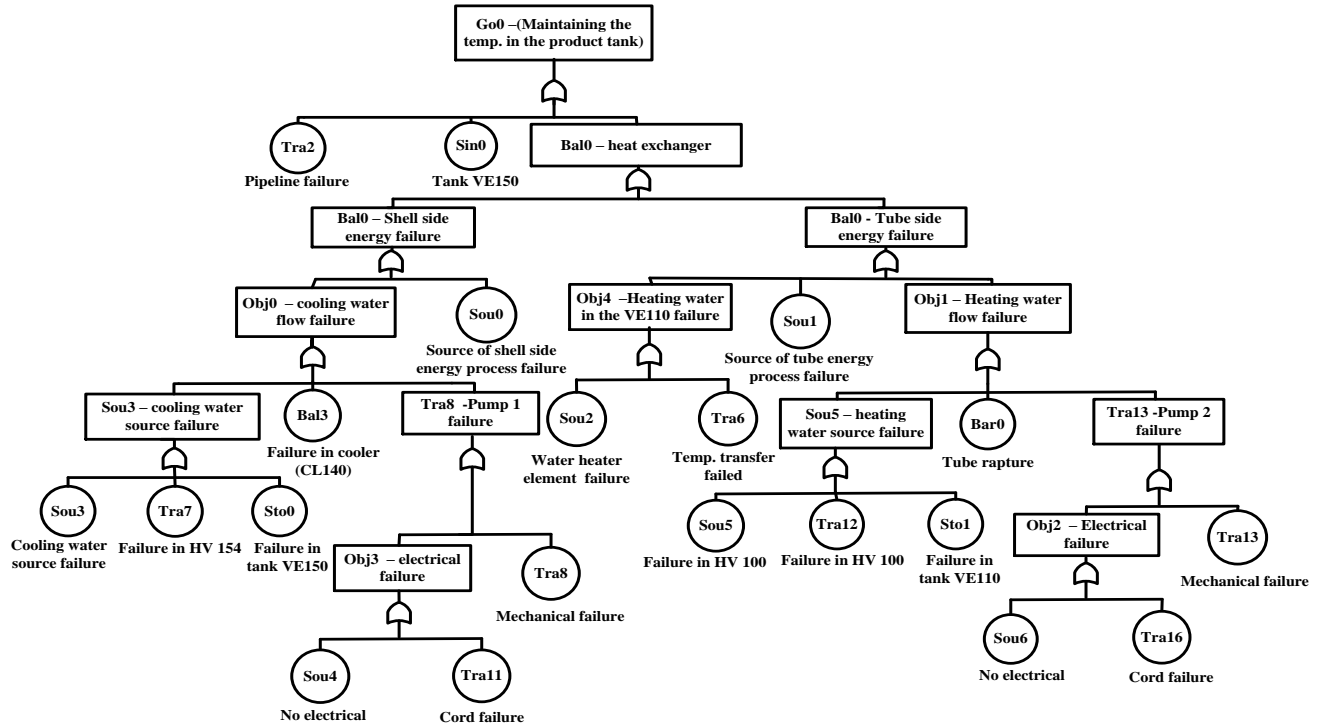

Figure 3 The FT of the MFM of the heat exchanger pilot plant [14]

Note that in Figure 3, all gates are “Or”, reflecting that the components can be represented by a series system in the MFM model. TE represents the failure to maintain water temperature in tank VE150 at the desired set point. Since this is the main function of the plant, for the MFM model, it is considered as the main goal. The failure to satisfy this main goal may results from the failure in one or more intermediate gates, i.e., Bal0 (heat exchanger fails to functioning) which results from the failure in the tube or shell sides, Obj0 (failure to cool water), Obj1 (heat exchanger fails to heat a water), Obj2 (electrical failure to provide electricity to the pump 2), Obj3 (electrical failure to provide electricity to the pump 1), Obj4 (heater in tank V110 fails to heat a water), Tra8 (pump 1 fails to transfer the cool water to the heat exchanger), Tra13 (pump 2 fails to transfer the water), Sou3 (failure to provide the system for the cold water), Sou5 (failure to provide the system for the hot water). All these will lead to the TE being false. The fault tree model of the system included only significant changes of plant states that are dependent on implicit assumptions about plant functions and operating conditions.

In Figure 4, the causal dependency graphic (CDG) is constructed from the MFM model of the heat exchanger system according to the direct influence relationships between flow functions as illustrated in table 2. Due to lack of space in this paper, only the CDG for MFS0 is considered, and a low flow delivered by pump2 (tra13) is used as a simple example. This leads to an unbalance state in the heat exchanger (Bal5), which in turn causes a low flow state and an unbalance state in the pipeline (tra14) and cooler (Bal6) respectively. In Figure 4, the state within the square (tra13) represents the root cause; the thick arrows representing the consequences path; the dashed arrow representing causal path and the states within a double circles are the observed states (consequences) (Bal5 and Ba6). There would be three faults, one primary (root cause) fault in pump2 low flow and two consequential, unbalance state in heat exchanger and cooler. The CDG can be used to predict or diagnose the fault of functions by using relationships between the process faults and their causes and consequences.

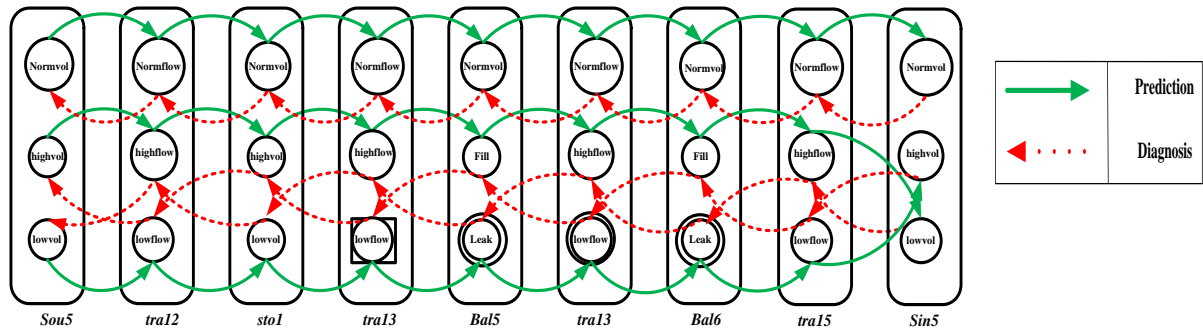

Figure 4 The Causal Dependency Graph between functions of the MFM in Figure2.

According to Table 1, the components are set in three states 0, 1, 2, where 0 is normal operation state, 1 is a state of fault state 1 (high or fill), 2 is fault state 2 (low or leak). Unbalance state is included in the leak

state in this study. The prior probability distributions of root nodes of the system shown in Table 3 are obtained by statistics and analysis of failure data of the elements of the system.

Table 2 Direct influences relationships between flow functions in MFM model in Figure 2

Pattern	Type of relation	Type of influence	cause		consequence	
			function	state	function	state
	Direct influence	Downstream	sou1	High/Low	tra1	High/ Low
	Direct influence	Downstream	sto1	High/Low	tra1	High/Low
	Direct participant	Downstream	tra1	High/Low	sto1	High/Low
	Direct participant	Downstream	tra1	High/Low	sin1	High/Low
	Direct influence	Upstream	sou1	High/Low	tra1	Low/ High
	Direct influence	Upstream	sto1	High/Low	tra1	Low/ High
	Direct influence	Upstream	tra1	High/Low	sto1	Low/ High
	Direct influence	Upstream	tra1	High/Low	sin1	Low/ High

Table 3 Prior probability distribution of root nodes of the system in Figure 3

Component	Flow Function	Component State probability		
		0 (Normal)	1(High)	2(Low)
Pipeline	Tra2	0.9999934552	6.48E-6	6.48E-8
Water tank	Sin0	0.99983869	1.598E-4	1.512E-6
Source S.S energy	Sou0	0.99321220	6.48E-3	3.078E-4
Cooler	Bal3	0.98635790	1.296E-2	6.821E-4
Cooling water source	Sou3	0.999997	2.0E-6	1.0E-6
Valve HV	Tra7	0.97273	2.7E-2	2.7E-4
Water tank	Sto0	0.99983869	1.598E-4	1.512E-6
Electricity supply	Sou4	0.99561520	4.32E-3	6.48E-5
Cord	Tra11	0.99727160	2.592E-3	1.364E-4
Pump1 mechanical	Tra8	0.928720	4.536E-2	2.592E-2
Source T.S energy	Sou1	0.99999318	6.48E-6	3.41E-7
Heating water source	Sou5	0.9704420	2.808E-2	1.478E-3
Valve HV	Tra12	0.97273	2.7E-2	2.7E-4
Tank	Sto1	0.99983869	1.598E-4	1.512E-6
Tube rupture	Bar0	0.999993179	6.48E-6	3.41E-7
Electricity supply	Sou6	0.99561520	4.32E-3	6.48E-5
Cord	Tra16	0.99727160	2.592E-3	1.364E-4
Pump2 mechanical	Tra13	0.928720	4.536E-2	2.592E-2
Heat transfer medium	Tra6	0.99999996	3.7962E-8	1.998E-9
Water heater elem.	Sou2	0.970442	0.02808	0.001478

5.0 RESULT AND DISCUSSION

Based on the BN model of the heat exchanger, using the prior probability of components and the CPT of the top event (G_0), and by applying accurate reasoning Bucket elimination algorithm [15] to calculate the probability, the probabilities are determined, giving value for the node G_0 , $P(G_0 = \text{FAULT-1}) = 0.0723$, $P(G_0 = \text{FAULT-2}) = 0.1628$, as shown in Figure 5. Note that in cases of no evidence, the probability of node G_0 and intermediate nodes cannot be determined.

Similarly, the posterior probability of each node can be deduced when the system is in completely

fault-1 state ($G_0 (\text{FAULT-1}) = 1$) or in case of completely fault-2 state ($G_0 (\text{FALUT-2}) = 1$), as is shown in Figure 6, Figure 7.

In the case of given evidence that G_0 is completely fault state ($G_0 = \text{FALUT-1}$ or $G_0 = \text{FALUT-2}$), all conditional probabilities for component nodes can be calculated.

Through analysis when system is in fully FAULT-1 state, the most influential factor is the Tra7 with failure probability (0.2753). When the system is in fully FAULT-2 state, the greatest impact factor is Pump2MechF node with failure probability (0.1387) as shown in Table 4.

Table 4 The failure probability of each component when system top node (TE) fault

Component node	Tra2		Sin0		Sou0	
	Fault -1	Fault -2	Fault -1	Fault -2	Fault -1	Fault -2
G0 (Fault -1)	8.18E-5	2.15E-7	6.76E-2	4.0E-4	9.8E-3	3.3E-3
G0 (Fault -2)	3.3E-6	3.01E-7	9.6E-3	1.7E-3	3.49E-2	4.0E-4
Component node	Bal3		Sto0		CWaterSouF	
	Fault -1	Fault -2	Fault -1	Fault -2	Fault -1	Fault -2
G0 (Fault -1)	0.1324	9.0E-4	1.6E-3	1.63E-5	2.21E-5	1.02E-5
G0 (Fault -2)	1.93E-2	3.7E-3	2.0E-4	1.61E-6	2.19E-6	1.47E-6
Component node	Tra7		Pump1MechF		Sou4	
	Fault -1	Fault -2	Fault -1	Fault -2	Fault -1	Fault -2
G0 (Fault -1)	0.2753	3.0E-3	5.07E-2	0.2755	7.7E-3	8.85E-5
G0 (Fault -2)	3.99E-2	3.0E-4	0.2499	3.33E-2	2.24E-2	3.0E-4
Component node	Tra11		Sou1		Bar0	
	Fault -1	Fault -2	Fault -1	Fault -2	Fault -1	Fault -2
G0 (Fault -1)	3.7E-3	2.0E-4	8.31E-5	2.56E-7	8.01E-5	6.93E-7
G0 (Fault -2)	1.39E-2	7.0E-4	2.38E-6	1.95E-6	3.51E-6	1.75E-6
Component node	HwaterSouF		Tra12		Sto1	
	Fault -1	Fault -2	Fault -1	Fault -2	Fault -1	Fault -2
G0 (Fault -1)	4.96E-2	1.5E-3	2.88E-2	5.0E-4	3.0E-4	1.6E-6
G0 (Fault -2)	0.1466	8.2E-3	0.1493	8.2E-3	8.0E-4	8.12E-6
Component node	Sou6		Tra16		Pump2MechF	
	Fault -1	Fault -2	Fault -1	Fault -2	Fault -1	Fault -2
G0 (Fault -1)	5.06E-2	1.0E-4	7.7E-3	1.6E-3	6.54E-2	3.81E-2
G0 (Fault -2)	3.4E-3	3.0E-4	1.21E-2	1.0E-4	0.2433	0.1387

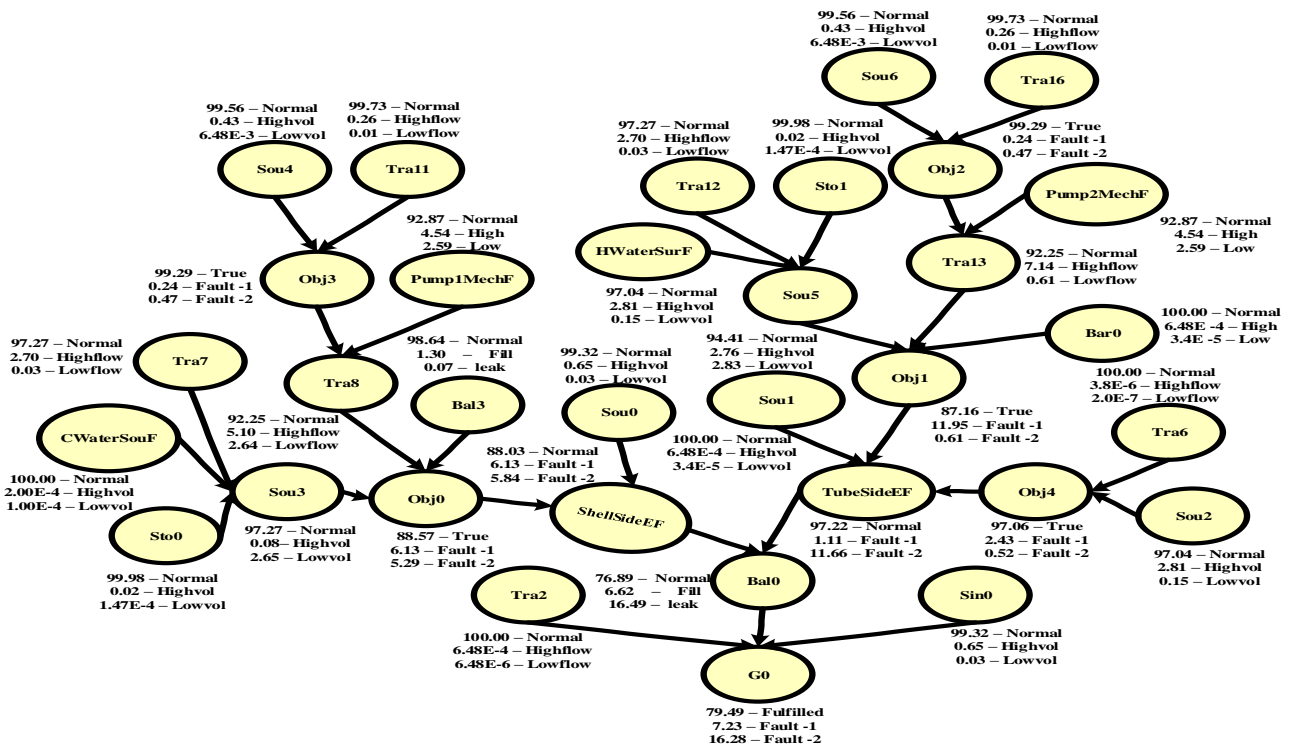

Figure 5 The Bayesian network of "the heat exchanger pilot plant" using the intermediate nodes

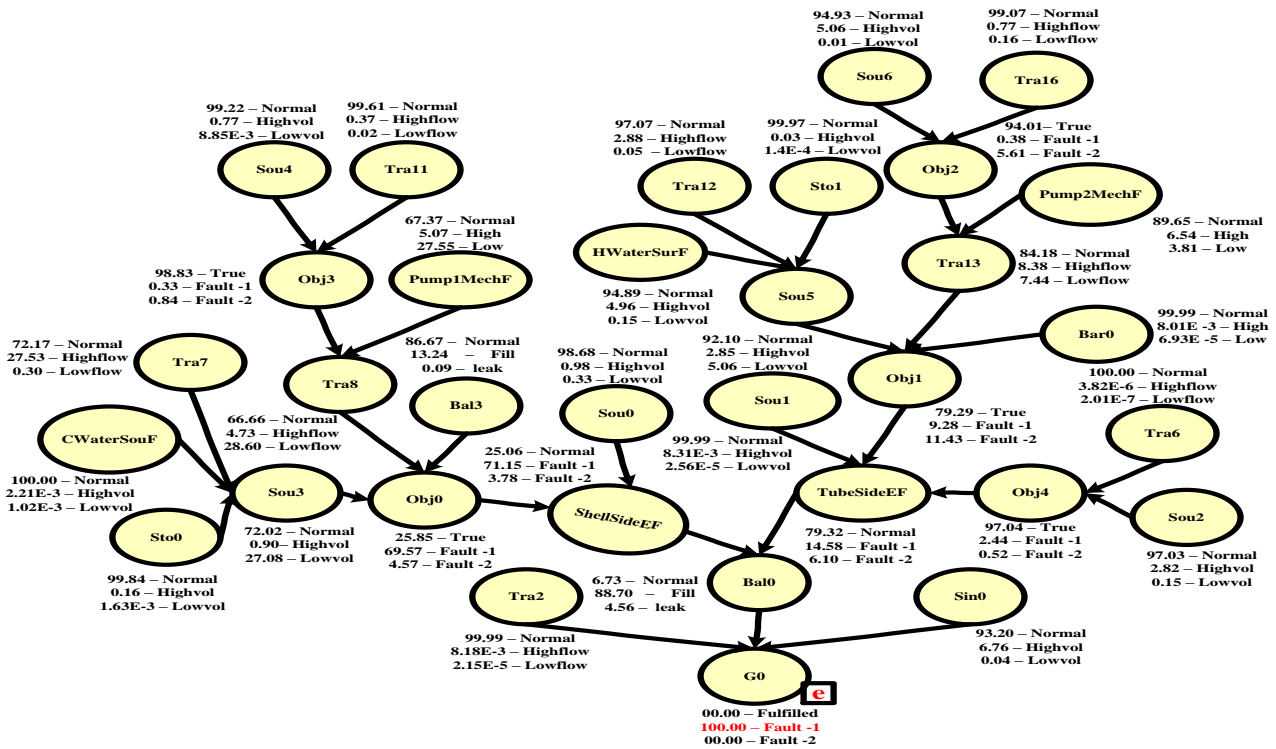

Figure 6 Posterior probability of each node when TE = FALUT - 1

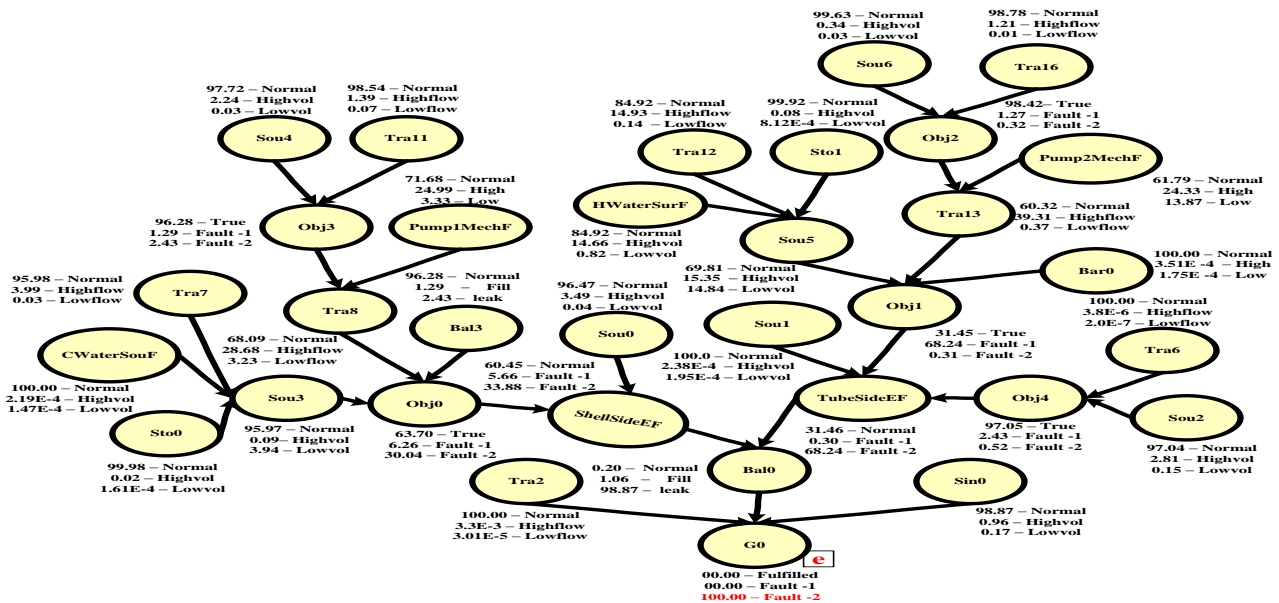

Figure 7 Posterior probability of each node when TE = FALUT - 2

6.0 CONCLUSION

A multi-state functional model based on MFM that has been transformed into an equivalent BN model has been used for fault detection and diagnosis in a heat exchanger pilot plant. Qualitative analyses have been represented by causal dependency graph (CDG) and failure probabilities of the root nodes as a quantitative analysis has been applied in a heat exchanger pilot plant. The results show the strength of this approach and can be considered as a useful

strategy for dealing with complex chemical processes.

Acknowledgement

The authors wish to express their gratitude to the Universiti Teknologi Malaysia for infrastructure and financial support through Research university grant scheme RUGS-07H12.

References

- [1] Ericson, C. A. 2005, *Hazard Analysis Techniques for System Safety*: John Wiley & Sons, Inc., 2005: 183.
- [2] Lind, M. 2011a. *Nuclear Safety and Simulation*. 2: 22.
- [3] Lind, M. 2011b. *Advances in Safety, Reliability and Risk Management*: ESREL 2011. 383.
- [4] Gofuku, A., S. Koide, N. Shimada. 2006. SICE-ICASE. *International Joint Conference: IEEE, 2006*: 497.
- [5] Petersen, J. 2000. *Proceedings of the cognitive systems engineering in process control (CSEPC 2000)*. 36.
- [6] Larsson, J.E. 2002. *Knowledge-Based Systems*, 2002: 103.
- [7] Mi, J., Y. Li, H.-Z. Huang, Y. Liu, X. Zhang. 2012. Quality, Reliability, Risk, Maintenance, and Safety Engineering (ICQR2MSE). *International Conference on: IEEE, 2012*: 1117.
- [8] Caldarola, L. 1980. *Nuclear Engineering and Design*. 58: 127.
- [9] Yi, R., K. Leixing. 2011. *Reliability, Maintainability and Safety (ICRMS)*, 9th International Conference on, 2011: 920.
- [10] Kai, Y. 1990. *Reliability Engineering & System Safety*. 28: 1.
- [11] Bossche, A. 1984. *Microelectronics Reliability*. 24: 707.
- [12] Barlow, R. E., A. S. Wu. 1978. *Mathematics of Operations Research*. 3: 275.
- [13] Dahlstrand, F. 1999. *Research and Development in Expert Systems XV*. 173.
- [14] Khalil, M. A. A., Arshad, Abdullah, Tuan Amran T. Al-shanini, Ali. 2016. *Chemical Product and Process Modeling*.
- [15] Dechter, R. 1998, *Learning In Graphical Models*: Springer, 1998: 75.